

Perfiles a Pedido

2 Indice de Perfiles























3 **Detalle de Perfiles en Escala 1:1**

Peso de las Barras de Perfiles: El peso por metro de los perfiles es estimado, con una tolerancia de + / - 10%.

Tener presente antes de emitir el pedido que se realizara un minimo de tirada de 300 kgs.

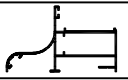
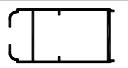
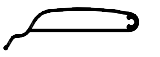
Largo de las Barras de Perfiles: La medida Standard de las Barras de Perfiles es de 6030 milímetros, salvo aclaración en contrario.

Alcemar S.A. se reserva el derecho de realizar cambios y/o modificaciones sin previo aviso de los artículos indicados en el presente Catálogo.

CODIGO	PESO (Kg/m)	T. x P.	DESCRIPCION	FORMA	PAG
5002	1,30	3	Parante de Puerta Bisagra Encoliz. Ref.		3
5020	0,68	4	Hoja V/S para Ventana Banderola, Ventana de Rebatir y Oscilo-Batiente		7
5021	0,65	4	Hoja DVH para Ventana Banderola, Ventana de Rebatir y Oscilo-Batiente		7
5070 (a)	0,72	4	Marco PF / VB/ VR/ VPdE		7
5071	0,69	4	Marco c/contramarco incorporado		6
5072	0,39	8	Cabezal de Zócalo		6
5073	0,39	8	Parante Lateral		6
5074	0,41	8	Parante Central		6
5075	0,65	4	Marco PF / VB/ VR/ VPdE		7
5076	0,63	4	Marco Corrediza		6
5098	1,08	4	Planchuela 80 x 5mm		3
5099	0,31	10	Moldura		3
5409 (a)	0,23	10	Batiente para Puerta de Rebatir - Línea Alcemar		4
5410	0,13	20	Tapacanto para Puerta de Rebatir - Línea Alcemar		4
5446	0,39	10	Planchuela 32 x 4.5mm		3
5460	0,85	4	Eje Octogonal de Cortina		3
5548	0,67	6	Complemento P/Puerta M5 Vaiven		3
5549	0,12	30	Tapa Canal Europeo		3
5550 (a)	0,82	2	Marco de Puerta		5
5551 (a)	0,78	3	Hoja de Puerta s/contravidrio		5
5623	0,53	6	Tablilla Cortina Regulable		4
5754	0,26	12	L 25 x 25 x 2mm		4
5793	0,47	6	Tapa		4
5853	0,17	20	PLanchuela 20x3mm		4

CODIGO	PESO (Kg/m)	T. x P.	DESCRIPCION	FORMA	PAG
5971	0,68	6	Parante Lateral		4
5972	0,56	6	Cabezal / Zócalo		4
5973	0,66	6	Parante Central		4
5998	1,50	3	Columna		5
5999	2,01	2	Columna		5

T. x P.: Tiras por Paquete

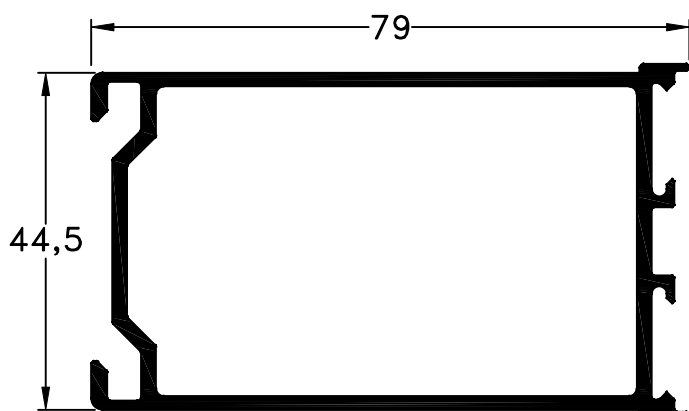

5002 - Parante de Puerta
Bisagra Encolizada
Reforzado
peso: 1,30 Kg/m

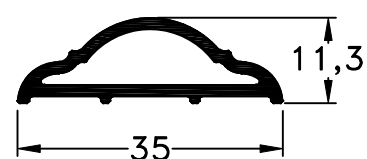

5099- Moldura
peso: 0,31Kg/m



5446 - Planchuela 32x4.5mm
peso: 0,39Kg/m



5098 - Planchuela 80x5mm
peso: 1,08Kg/m

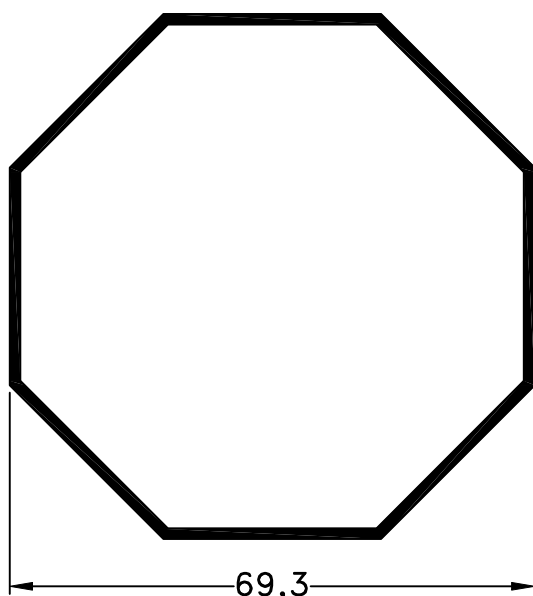

5460 -Eje Octogonal de Cortina
peso: 0,85Kg/m

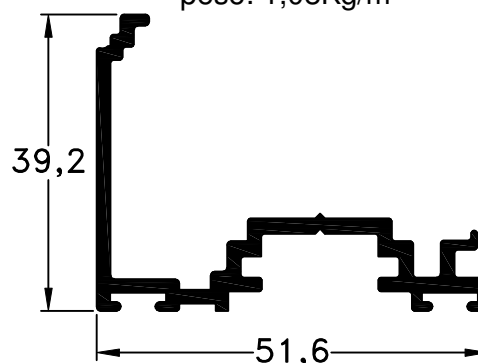

5548 - Complemento P/Pta M5 Vaivén
peso: 0,67Kg/m

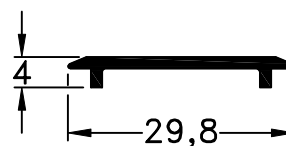

5549- Tapa Canal Europeo
peso: 0,12Kg/m

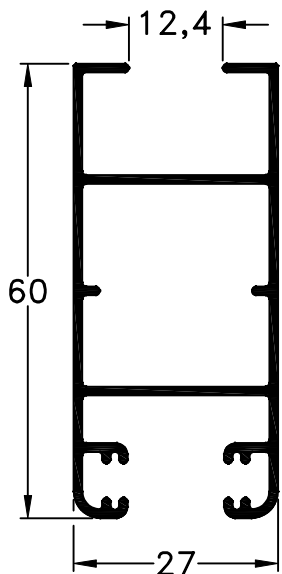

5971- Parante Lateral
peso: 0,68Kg/m

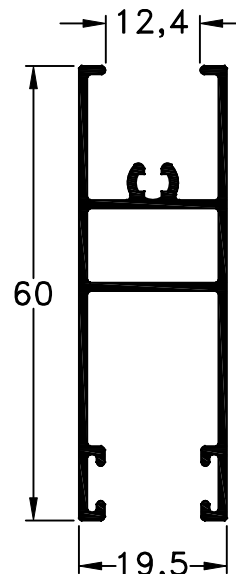

5972- Cabezal / Zócalo
peso: 0,56Kg/m

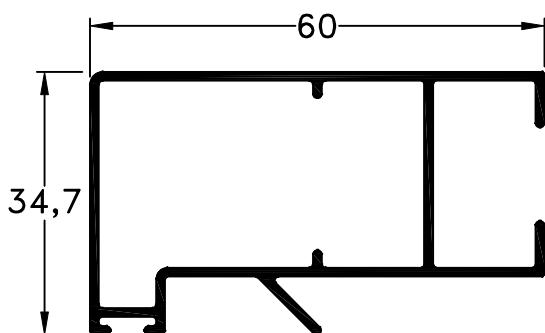

5973 - Parante Central
peso: 0,66Kg/m

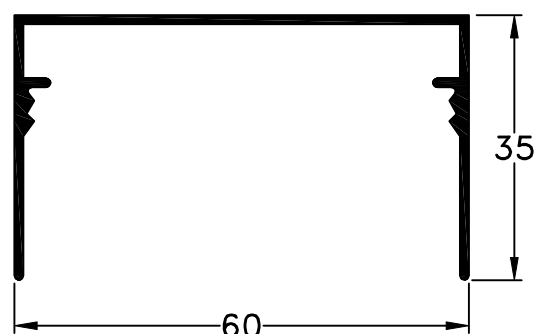

5793 -Tapa
peso: 0,47Kg/m

5853 -Planchuela 20x3mm
peso: 0,17Kg/m

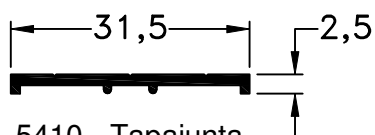

5410 - Tapajunta
peso: 0,13 Kg/m

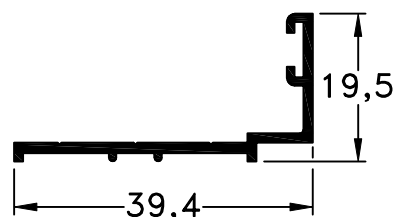

5409 - Batiente
Largo Std.: 6150 mm
peso: 0,23 Kg/m

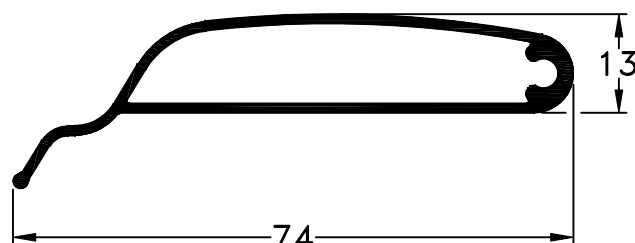

5623- Tablilla Cortina Regulable
peso: 0,53Kg/m

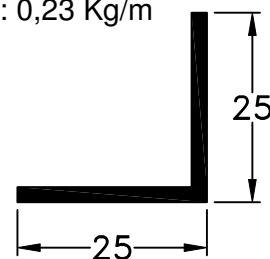

5754 -L 25x25x2mm
peso: 0,26Kg/m

Escala 1:1

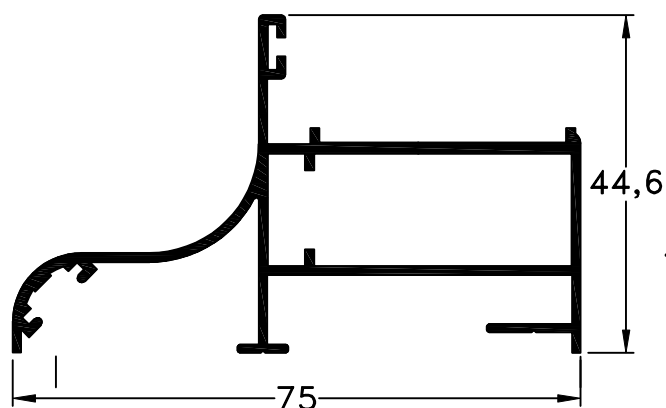

5550 - Marco Puerta de Rebatir
Largo Std.: 6150 mm
peso: 0,82 Kg/m

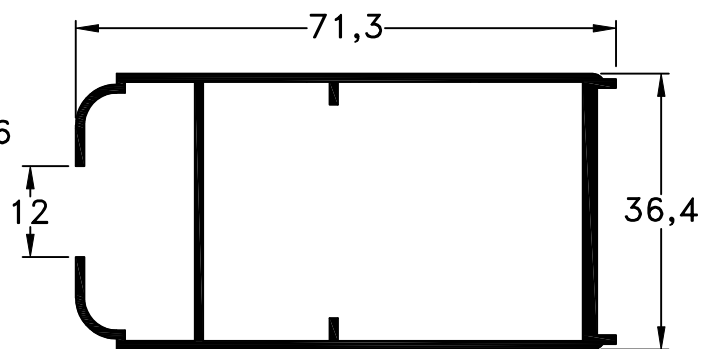

5551 - Parante
Largo Std.: 6150 mm
peso: 0,78 Kg/m

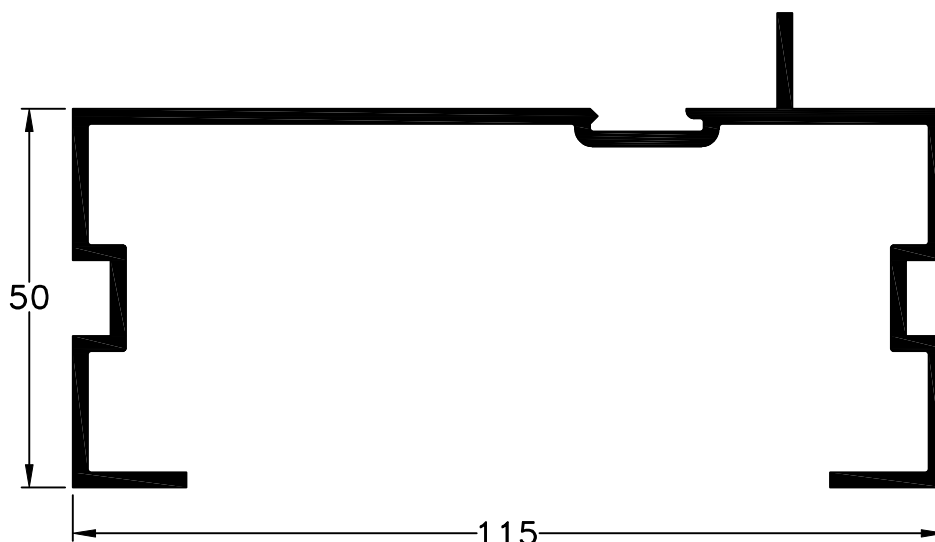

5998 - Columna
peso: 1,50Kg/m

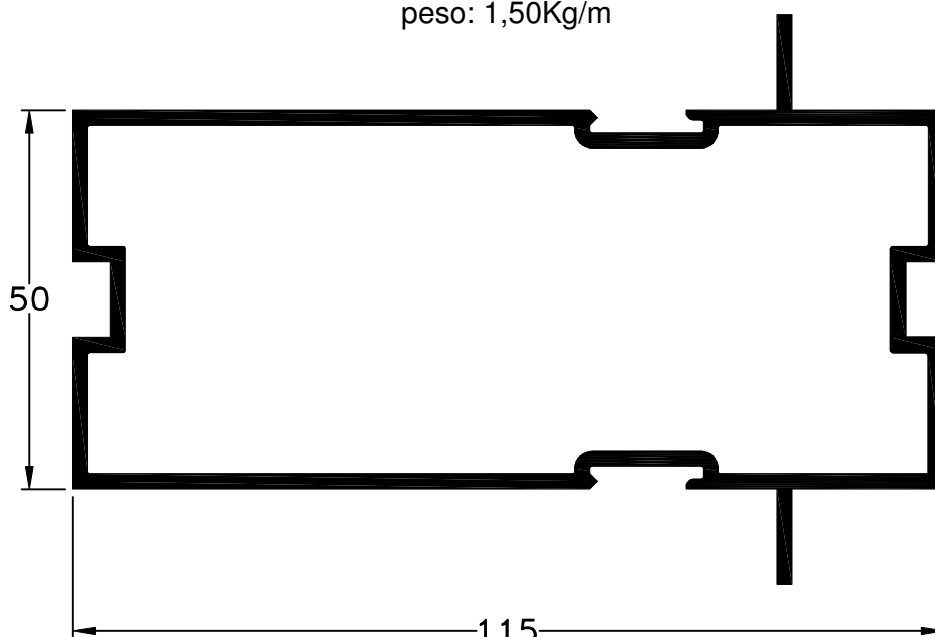

5999 - Columna
peso: 2,01Kg/m

Escala 1:1

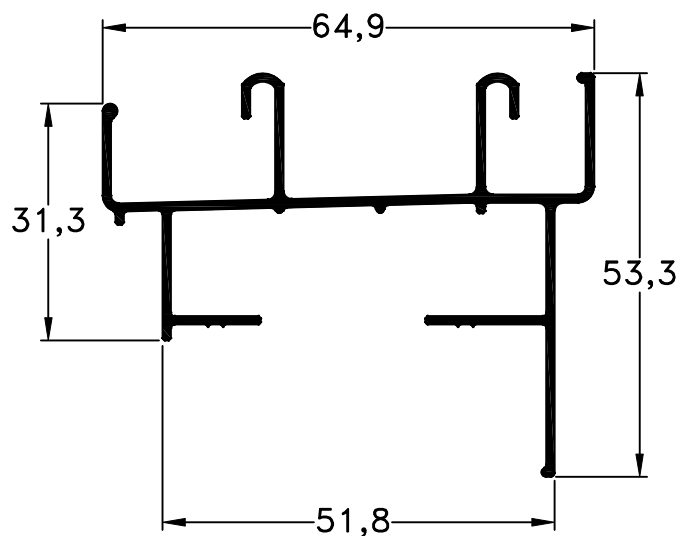

5071 - Marco con Contramarco
peso: 0,69 Kg/m

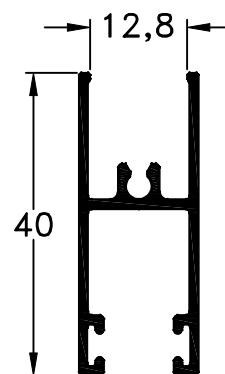

5072 - Cabezal - Zócalo
peso: 0,39 Kg/m

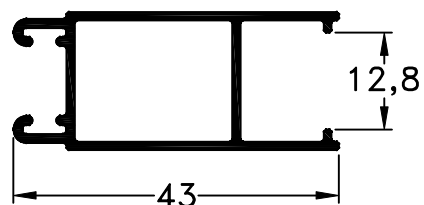

5073 - Parante Lateral
peso: 0,39 Kg/m

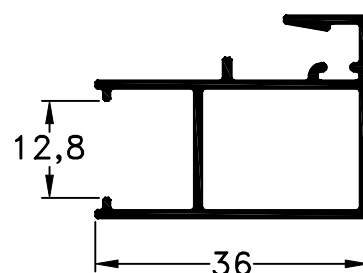

5074 - Parante Central
peso: 0,41 Kg/m

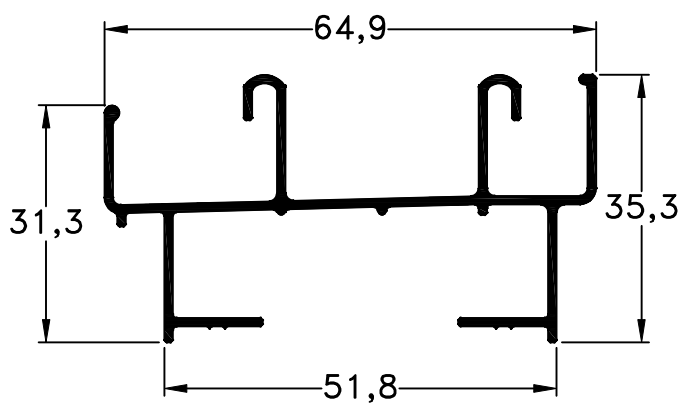

5076 - Marco Corredizas
peso: 0,63 Kg/m

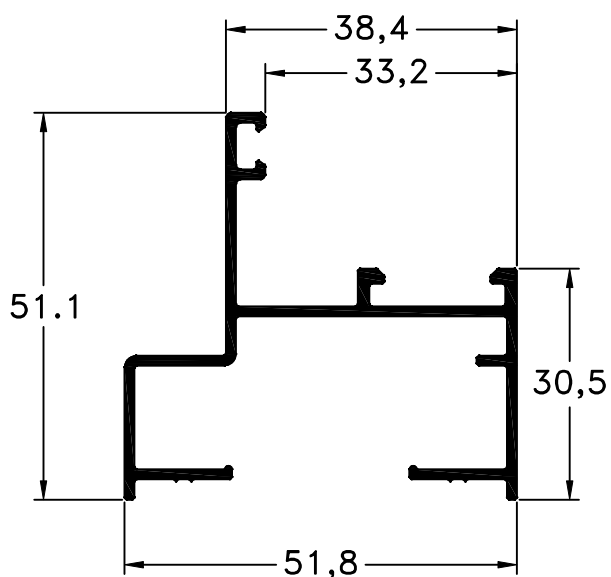

5075 - Marco Fijos y
Ventana Doble Contacto
peso: 0,65 Kg/m

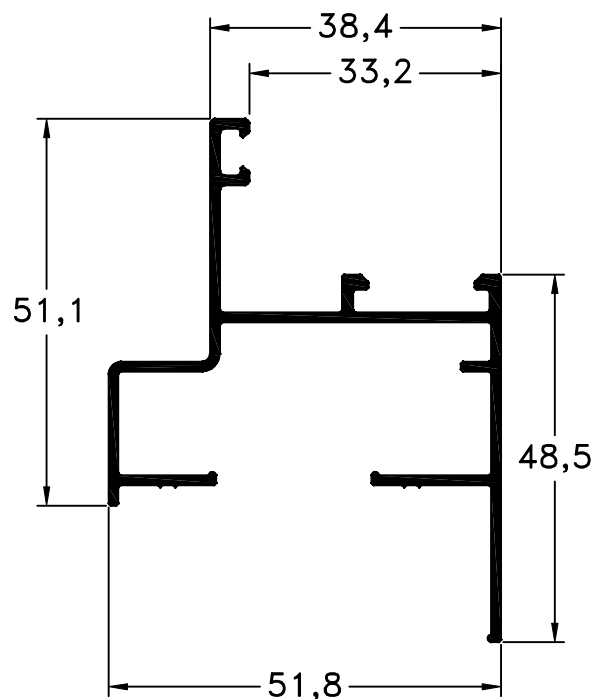

5070 - Marco Fijos y
Ventana Doble Contacto
peso: 0,72 Kg/m

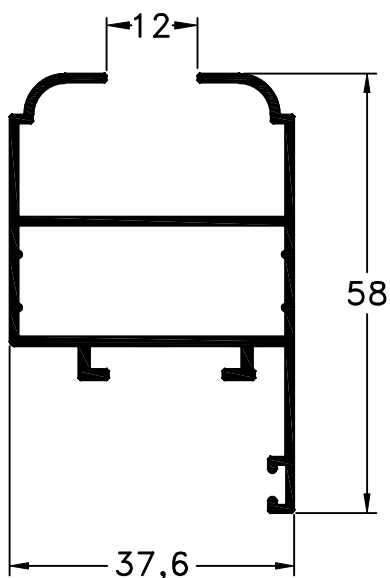

5020 - Hoja
peso: 0,68 Kg/m

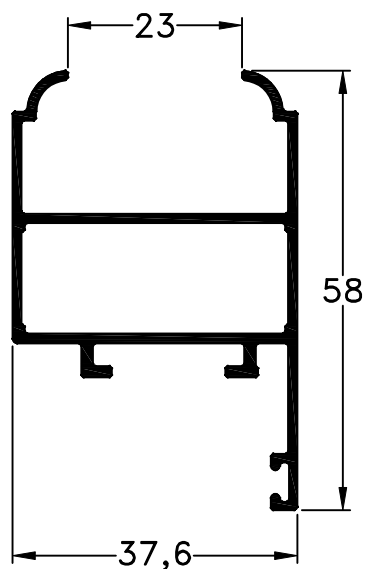

5021 - Hoja
peso: 0,65 Kg/m