

B-B Corte Vertical con Poliamida de 25 mm en marco.

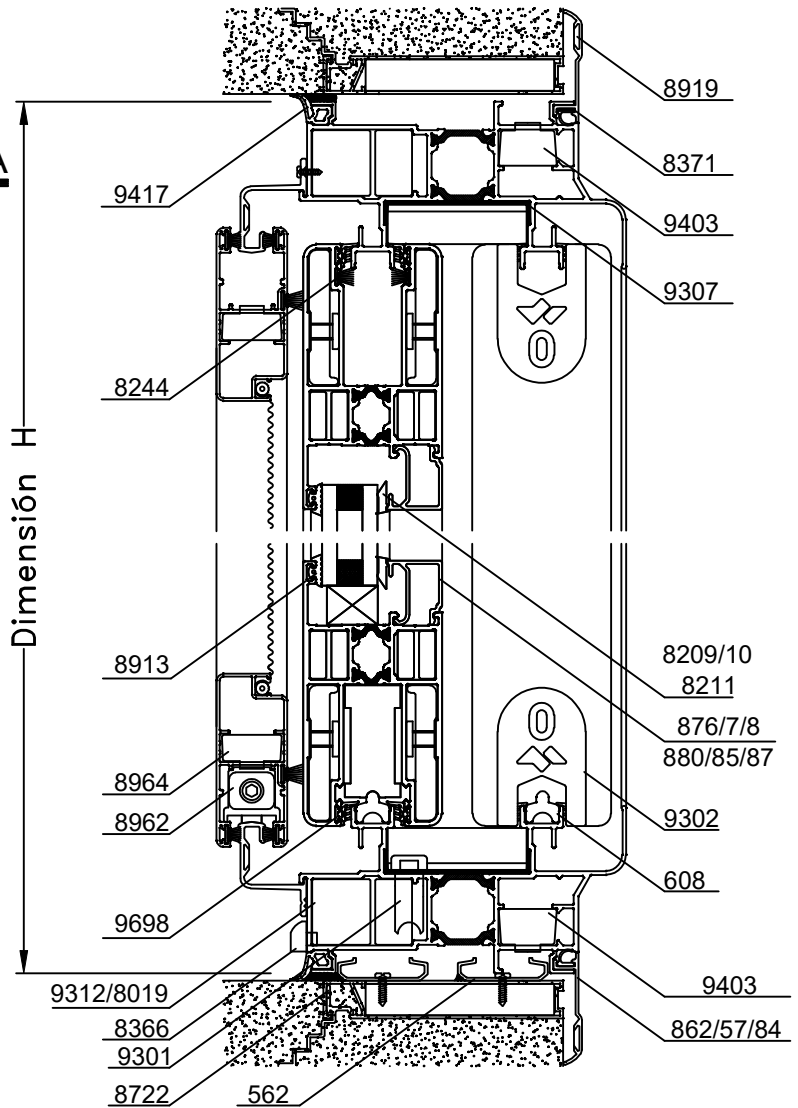

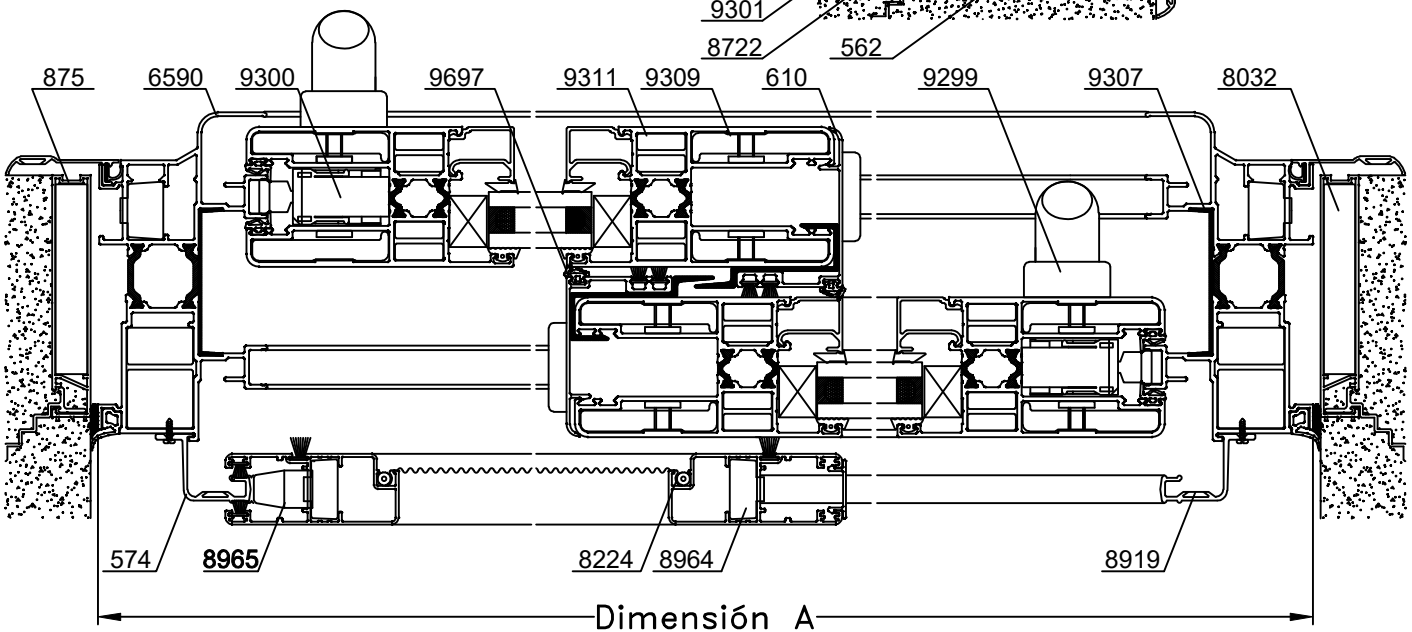



A-A Corte Horizontal con Poliamida de 25 mm. en marco





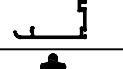
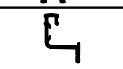
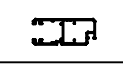
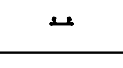

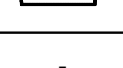
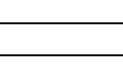





Escala 1:3
Tolerancia en Peso +/- 10%

21-03-18 **MEDITERRANEA-RPT.58**

Dimensiones de Corte						
Código	Peso Kg/m	Forma	Función	Cant.	Largo	Corte
6590	2.63		Marco	2	A	45° 45°
				2	H	45° 45°
6600	2,65		Hoja	4	A/2-6	45° 45°
				4	H-115	45° 45°
610	0,50		Encuentro	2	H-115	90° 90°
608	0,26		Guía Inf.	2	A-119	90° 90°
574	0,38		Guía Mosquit.	2	A-45	45° 45°
				2	H-45	45° 45°
738	0,80		Guía Mosquit.	2	A/2+2	45° 45°
				2	H-100	45° 45°
739	0,12		Tapa	1	H-100	90° 90°
9308	-		Perfil Plastico J	2	H-115	90° 90°
9307	-		Perfil Plastico U	2	A-79	45° 45°
				2	H-79	45° 45°
876/877/878	-	-	Contra-vidrio	4	A/2-176	90° 90°
880/885/887	-	-		4	H-326	90° 90°

- Dimensiones de Corte Contramarco: pág. 24
 - Dimensiones de Corte Premarco: pág. 25

* Medidas en milímetros

Detalle de Accesorios				
Ítem	Código	Descripción	Forma	Cantidad
Esc. de Marco	8019	Escuadra de Armado Marco Descentrada E-22		4 Unidades
	9312	Escuadra de Armado Marco Descentrada E-22 de expans.		
Esc. de Hoja	9311	Escuadra de Armado Hoja	-	8 Unidades
Esc. de Alin. Hoja	9309	Escuadra de Alineación Inyectada	-	16 Unidades
Cuña Vidrio	8209	Cuña Chica		4A + 8H
	8210	Cuña Mediana		
	8211	Cuña Grande		
Burlete Exterior	9417	Burlete Exterior Cubre Sello		2A + 2H
Felpa Encuentro	8942	Felpa de 7x6		4H
Felpa Sup. Hoja	8244	Felpa de 7x8 con Fin Seal		2A
Burlete Hermet.	9698	Burlete Hermeticidad Hoja Elevable		4A + 4H
	9697	Burlete Hermeticidad Encuentro de Hoja		2H
Mecanismo	9300	Mecanismo Elevable HS 300 - 300 kg por hoja	-	2 Unidades
Manija	9299	Manija para Mecanismo Elevable HS 300	-	
Tope Lateral	9314	Tope de Hoja Mediterranea M-Siete		2 Unidades
Tope Central	9302	Tope Central Hoja M-Siete		4 Unidades
Cruce de Hoja	9303	Cruce de Hoja de 50 mm	-	2 Unidades
Boca Desagüe	9301	Boqueta de Desagüe a Caja de Agua	-	s/m
Tapa Desagüe	8366	Tapa Desagüe T-69		2 Unidades
Tornillos	8941	Tornillo Fijador Encuentro Central		s/m
Tapa Inercial Opcional	9313	Tapón Refuerzo Inercial Parante Central	-	2 Unidades

Accesorios Contramarco: pág. 24 Accesorios Premarco: pág. 25

s/m: según medida.

Tolerancia en Peso +/- 10%

21-03-18 **MEDITERRANEA-RPT.59**