

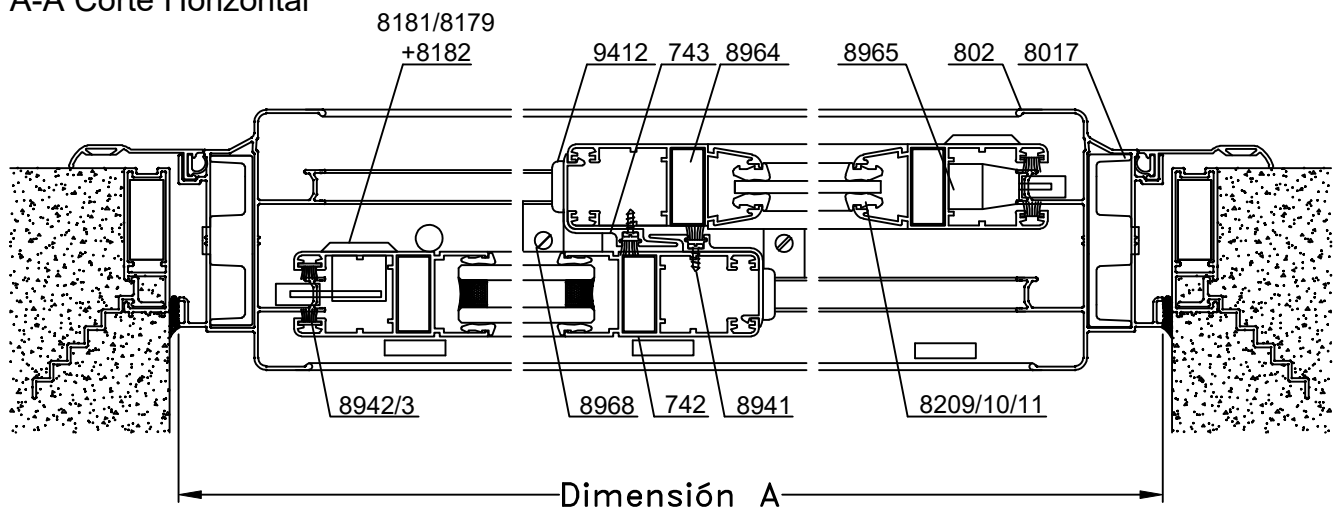

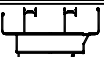



A-A Corte Horizontal



Escala 1:2.5
Tolerancia en Peso +/- 10%

















12-12-16 **MEDITERRANEA.36**

Dimensiones de Corte						
Código	Peso Kg/m	Forma	Función	Cant.	Largo	Corte
802	1,09		Marco	2	A	45° 45°
				2	H	45° 45°
787 (V.S) 742 (D.V.H)	0,80 0,77		Hoja	4	A/2-6	45° 45°
				4	H-81	45° 45°
743	0,29		Encuentro Central	2	H-81	90° 90°
561	0,09		Guía Inferior	2	A-92	90° 90°
730	0,80		Travesaño p/741	2	A/2-101	90° 90°
681	0,70		Travesaño p/742	2	A/2-101	90° 90°

Dimensiones de Corte Contramarco: pág. 27

* Medidas en milímetros

Dimensiones de Corte Premarco: pág. 28

Detalle de Accesorios				
Ítem	Código	Descripción	Forma	Cantidad
Esc. de Armado	8017	Esc. de Armado Mediterránea E21-1		4 Unidades
	8964	Esc. de Armado Hoja CON-359		8 Unidades
	8949	Escuadra de Armado Hoja E-98		16 Unidades
Tornillos	8941	Tornillo Fijador Perfil 743		s/m
Cuña Vidrio	8209	Cuña Chica		4A + 8H
	8210	Cuña Mediana		
	8211	Cuña Grande		
Burlete Exterior	9417	Burlete Exterior Tapa de Sellado		2A + 2H
Felpa (Ver nota "a")	8942	Felpa de 7x6		4A + 6H
	8943	Felpa de 7x6 con Fin Seal		
Manija	9438/39	Manijas Acodadas Izquierda / Derecha	-	2 Unidades
	9430/31/32	Mecanismo de Cierre de 1, 2 y 3 Puntos	-	2 Unidades
Cierre Lateral	8181-8179	Cierre Lateral Milano (Automático o Manual 2 P.)		2 Unidades
	8182	Kit de Cierre Lateral Milano para M-Uno		
Tope Lateral	8965	Tope Lateral BAT-937		1 Juego
Rodamientos	8962	Rueda Simple 3304		4 Unidades
	8967	Rueda Simpl. Reg. c/Rul. (Max 50 Kg/Hoja)		
	8963	Rueda Dobl. Reg. c/Rul. (Max. 100Kg/Hoja)		
	9154	Rueda Dobl. Reg. c/Aguj. (Max. 150Kg/Hoja)		
	8130	Rueda Dobl. Reg. Optimus (160Kg/Hoja)		
Tope Central	9412	Tope Central		4 Unidades
Cruce de Hoja	9142	Cruce de Hoja		2 Unidades
Boca Desagüe	8946	Boca Desagüe T-94		s/m
Tapa Desagüe	8366	Tapa Desagüe T-69		2 Unidades
Tapón Hermetic.	8383	Tapón de Hermeticidad Caja de Agua		2 Unidades
Tapón (Opción con Tirador)	9708	Tapón Tirador Central, Perfil 518		2 Unidades

 s/m: según medida - Accesorios Contramarco: pág. 27 - Premarco: pág. 28
 Nota "a": Se recomienda felpa sin fin seal en los encuentros de hoja.