

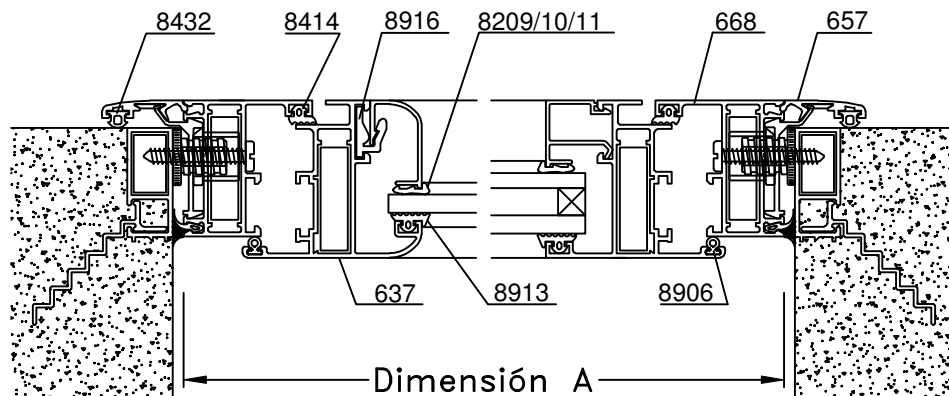



A-A Corte Horizontal









Escala 1:2.5  
Tolerancia en Peso +/- 10%

25-07-15 **DELTA.35**

Dimensiones de Corte Ventana Ventiluz						
Función	Código	Peso Kg/m	Forma	Cant.	Largo	Corte
Marco	668	0,66		2	A	45° 45°
				2	H	45° 45°
Hoja	637	0,90		2	A-39	45° 45°
				2	H-39	45° 45°
	688	0,85		2	A-39	45° 45°
				2	H-39	45° 45°
Contra Vidrio	Contra vidrios Curvos	-	-	2	A-123	45° 45°
				2	H-123	45° 45°
	Contra vidrios Rectos	-	-	2	A-123	90° 90°
				2	H-157	90° 90°

- Medidas en milímetros

- Dimensiones de Corte de Premarco y Contramarco, en página 5 5

Detalle de Accesorios Ventana Ventiluz			
Código	Descripción	Forma	Cantidad
8423	Escuadra de Armado E-69		8 Unidades
8916	Clip Contra Vidrio T-96		s/m
8913	Burlete de Acristalamiento B-68		2A + 2H
8209	Cuña Chica		2A + 2H
8210	Cuña Mediana		
8211	Cuña Grande		
8906	Burlete AEL Europeo		2A + 2H
8914	Burlete de Hermeticidad B-67		2A + 2H
8930	Brazo Ombú Largo 224 mm. H-63		1 Unidad(*)
8931	Brazo Ombú Corto 160 mm. H-63		
8908	Bisagra H-61 de 2 piezas con Kit		2 Unidades
8366	Tapa Desague T-69		2 Unidades

- Detalle de Accesorios para Fijación, Premarco y Contramarco en página 5 5

- s/m : según medida

(\*) En hojas de medidas superiores a 800mm de ancho se aconseja colocar 2 brazos de empuje