



# línea Delta



[www.alcemar.com.ar](http://www.alcemar.com.ar)

2	.....	Indice de Perfiles
5	.....	Detalles de Perfiles en Escala 1:1
		Detalle de Armado
17	.....	Paño Fijo Recto y Curvo
19	.....	Ventana de Rebatir de 1 Hoja, Cámara Ecuilizador de Presiones
21	.....	Ventana de Rebatir de 2 Hojas, Cámara Ecuilizador de Presiones
23	.....	Ventana Oscilo-Batiente de 1 Hoja, Cámara Ecuiliz. de Presiones
24	.....	Ventana Oscilo-Batiente de 2 Hojas, Cámara Ecuiliz. de Presiones
25	.....	Ventana Banderola, Cámara Ecuilizador de Presiones
27	.....	Ventana de Rebatir de 1 Hoja, Doble Contacto
29	.....	Ventana de Rebatir de 2 Hojas, Doble Contacto
31	.....	Ventana Oscilo-Batiente de 1 Hojas, Doble Contacto
32	.....	Ventana Oscilo-Batiente de 2 Hojas, Doble Contacto
33	.....	Ventana Banderola, Doble Contacto
35	.....	Ventana Ventiluz, Doble Contacto
37	.....	Puerta de Rebatir de 1 Hoja Sin Contravidrio Exterior
39	.....	Puerta de Rebatir de 1 Hoja
41	.....	Puerta de Rebatir de 2 Hojas
43	.....	Ventana y Puerta Corrediza de 2 Pistas para Vidrio Simple o Laminado
45	.....	Ventana y Puerta Corrediza de 2 Pistas para DVH
47	.....	Ventana y Puerta Corrediza de 3 Pistas para Vidrio Simple o Laminado
49	.....	Ventana y Puerta Corrediza de 3 Pistas para DVH
51	.....	Ventana Desplazable, Doble Contacto
53	.....	Ventana Guillotina Auto-Compensada
55	.....	Accesorios para Premarco, Contramarco y Mosquitero
56	.....	Cálculo de Componentes y Cortes para Ventanas Oscilo-Batientes













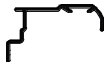





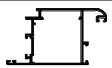
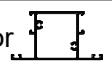
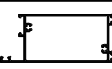

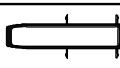

Dimensiones de corte: Las medidas de corte contenidas en el presente catálogo son válidas únicamente para el armado de un prototipo, mediante el cual se deberá verificar el adecuado funcionamiento de todos los componentes a utilizar (Perfiles de Aluminio, Accesorios, Vidrios, etc.) antes de iniciar la producción en serie.

Peso de las Barras de Perfiles: El peso por metro de los perfiles es estimado, con una tolerancia de + / - 10%.

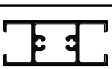
Largo de las Barras de Perfiles: La medida Standard de las Barras de Perfiles es de 6030 milímetros, salvo aclaración en contrario.















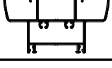
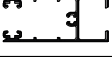
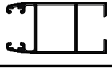



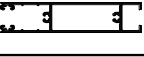

Alcemar S.A. se reserva el derecho de realizar cambios y/o modificaciones sin previo aviso de los artículos indicados en el presente Catálogo.

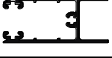
09-06-23 DELTA.1

CODIGO	PESO (Kg/m)	T. x P.	DESCRIPCION	FORMA	PAG
129	0,12	20	Tapa Doble Compensador		14
151(a)	0,24	12	Contramarco 32mm		16
152(a)	0,26	12	Contramarco 39mm		16
506	0,69	6	Zócalo y Cabezal de Hoja para Ventana Guillotina		14
507	0,56	6	Hoja para Ventana Guillotina		14
508	0,17	20	Contravidrio para Ventana Guillotina		14
509	0,14	20	Tapa Compensador		14
510	0,15	20	Contravidrio para Ventana Guillotina		14
614 (a)	1,15	4	Hoja de Puerta sin Contravidrio Exterior		12
615	1,09	4	Travesaño de Puerta sin Contravidrio Exterior		12
616	1,29	3	Zócalo de Puerta sin Contravidrio Exterior		12
629	0,77	4	Travesaño Angosto ( Paño Fijo )		9
632	0,32	12	Contravidrio Recto 36 m/m. ( complementos )		13
633	0,26	12	Contravidrio Recto 22 m/m. ( complementos )		13
634 (a)	1,24	3	Acople columna reforzado ( complementos )		16
635	0,91	4	Hoja Recta ( Ventana de Abrir Cámara Comp. )		10
636 (a)	0,92	4	Encuentro central cep ( Ventana de abrir camara comp. )		8
637 (a)	0,90	4	Hoja Curva ( ventiluz )		10
638	0,70	5	Travesaño ( Ventana / Puerta corrediza )		6
639 (a)	0,99	4	Hoja Curva s/Contravidrio v.s ( vent. de abrir doble contacto )		10
640 (a)	1,00	4	Hoja Curvas/Contravidrio d.v.h ( vent. de abrir doble contacto )		10
641(a)	0,32	12	Contramarco ( Complementos )		15
642 (a)	0,29	12	Encuentro de 4 hojas ( Corrediza )		6
643	1,10	4	Marco para Ventana Guillotina		14



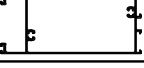







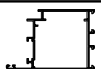

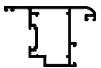



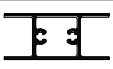

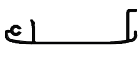
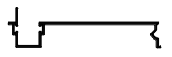

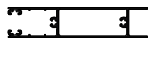
Referencia (a): Largo de la Barra 6150 milímetros  
Tolerancia en Peso +/- 10% Tolerancia largo +10 mm -0 mm

T. x P.: Tiras por Paquete  
09-06-23 DELTA.2

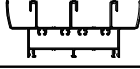
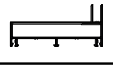
CODIGO	PESO (Kg/m)	T. x P.	DESCRIPCION	FORMA	PAG
644	0,18	20	Contravidrio Recto Exterior ( Puerta de Rebatir )		11
645	0,21	16	Contravidrio Recto 15 m/m. ( complementos )		13
646	0,29	12	Contravidrio Recto 29 m/m. ( complementos )		13
649 (a)	0,19	20	Contramarco recto ( Complementos )		15
651 (a)	1,21	4	Umbral y Dintel ( Ventana / Puerta corrediza )		5
652	0,64	5	Zócalo ( Ventana corrediza )		6
653 (a)	0,64	5	Parante lateral ( Ventana / Puerta corrediza )		6
654 (a)	0,58	8	Parante central ( Ventana corrediza )		6
655 (a)	0,59	6	Jamba ( Ventana / Puerta corrediza )		5
656 (a)	0,70	6	Marco ( Paño Fijo Curvo )		8
657 (a)	0,19	20	Contramarco ( Complementos )		15
658 (a)	0,68	2	Columna Curva a 90° ( Complementos )		16
659 (a)	0,54	5	Columna Curva a 45° ( Complementos )		16
660	1,26	4	Zócalo ( Puerta Corrediza )		6
661 (a)	0,79	4	Hoja Curva ( Ventana de Abrir Cámara Comp. )		8
662 (a)	0,71	6	Marco ( Ventana de Abrir Cámara Comp. )		8
663	0,68	5	Zócalo D.V.H. ( Ventana Corrediza )		7
664 (a)	0,56	8	Parante CENTRAL D.V.H. ( Ventana Corrediza )		7
665 (a)	0,59	5	Parante Lateral D.V.H. ( Ventana / Puerta Corrediza )		7
666	0,16	20	Contravidrio Curvo 15 m/m. ( Complementos )		13
667	0,21	20	Contravidrio Curvo 29 m/m. ( Complementos )		13
668 (a)	0,66	6	Marco ( Ventana de Abrir D.C. / Banderola Puerta de Rebatir / Ventiluz / P.F. Recto )		9
669	1,63	2	Zócalo ( Puerta de Rebatir )		11
670	1,01	3	Travesaño ( Puerta de Rebatir )		11

Referencia (a): Largo de la Barra 6150 milímetros  
Tolerancia en Peso +/- 10% Tolerancia largo +10 mm -0 mm

T. x P.: Tiras por Paquete  
09-06-23 DELTA.3

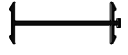
CODIGO	PESO (Kg/m)	T. x P.	DESCRIPCION	FORMA	PAG
671 (a)	0,94	4	Parante ( Puerta de Rebatir )		11
672	0,18	20	Contravidrio Curvo Exterior ( Puerta de Rebatir )		11
675 (a)	1,07	4	Hoja ( Ventana Proyectante )		13
676 (a)	0,72	6	Marco ( Ventana Proyectante )		13
677 (a)	0,79	4	Parante Lateral con Tirador ( Puerta Corrediza )		6
680	0,18	20	Contravidrio Curvo 22 m/m. ( Complementos )		13
681	0,70	5	Travesaño D.V.H. ( Ventana / Puerta Corrediza )		7
682 (a)	0,27	15	Bisagra Tapacinta ( Complementos )		15
683 (a)	0,60	6	Tapacinta ( Complementos )		15
684 (a)	0,89	4	Guía Barrio ( Complementos )		15
685	0,38	10	Mosquitero ( Ventana / Puerta Corrediza )		5
686	1,23	4	Zócalo D.V.H. ( Puerta Corrediza )		7
687 (a)	0,76	4	Parante Lateral con Tirador D.V.H. ( Puerta Corrediza )		7
688 (a)	0,85	5	Hoja Recta ( Ventiluz )		9
689	0,24	20	Contravidrio Curvo 36 m/m. ( Complementos )		13
690	0,14	20	Contravidrio Curvo 7 m/m. ( Complementos )		13
691 (a)	1,83	2	Umbral y Dintel de 3 Guías ( Ventana / Puerta Corrediza )		5
692 (a)	0,98	2	Jamba de 3 Guías ( Ventana / Puerta Corrediza )		5
694 (a)	0,80	4	Encuentro Central Doble Contacto ( Ventana / Puerta de Rebatir )		11
695 (a)	0,86	4	Hoja Recta ( Ventana de Abrir Doble Contacto )		9
696 (a)	0,90	4	Hoja Curva ( Ventana de Abrir Doble Contacto )		10
708	0,19	20	Tope Mosquitero ( Ventana y Puerta Corrediza )		5
718 (a)	0,33	10	Premarco ( Complementos )		15
720 (a)	0,26	8	Acople ( Complementos )		16

Referencia (a): Largo de la Barra 6150 milímetros  
Tolerancia en Peso +/- 10% Tolerancia largo +10 mm -0 mm

T. x P.: Tiras por Paquete  
09-06-23 DELTA.4

CODIGO	PESO (Kg/m)	T. x P.	DESCRIPCION	FORMA	PAG
722 (a)	0,49	8	Guía Común ( Complementos )		15
840 (a)	0,63	4	Premarco de 69.5mm		9
863 (a)	0,21	20	Contramarco de atornillar		15
9469	0,07	-	Varilla Parte Omega de Poliamida ( Complementos )		8

Referencia (a): Largo de la Barra 6150 milímetros

T. x P.: Tiras por Paquete

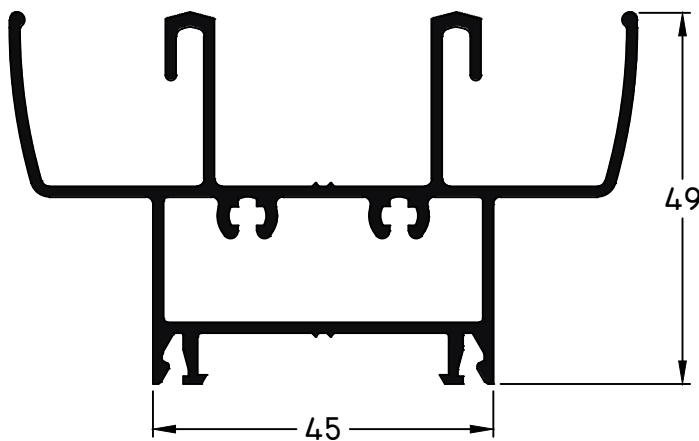

651 - Umbral y Dintel  
Largo Std.: 6150 mm  
peso: 1,21 Kg/m

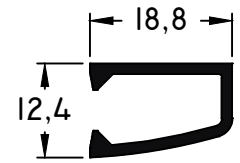

708 - Tope Mosquitero  
peso: 0,19 Kg/m

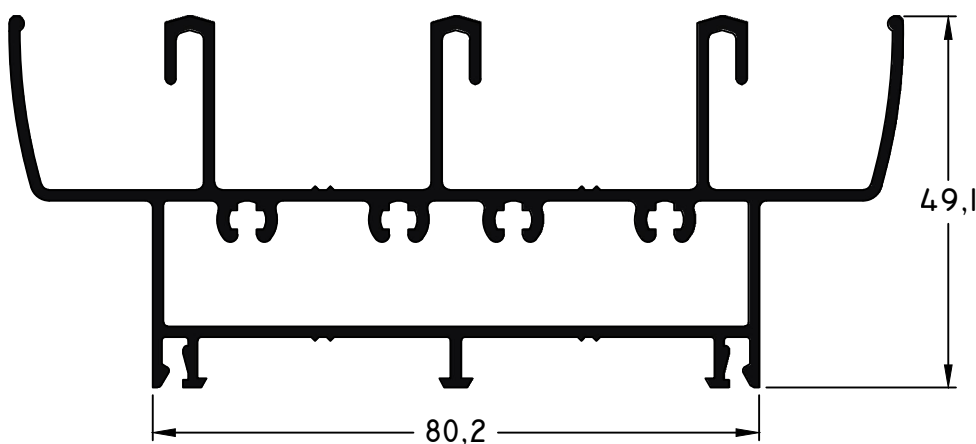

691 - Umbral y Dintel de 3 Guías  
Largo Std.: 6150 mm  
peso: 1,83 Kg/m

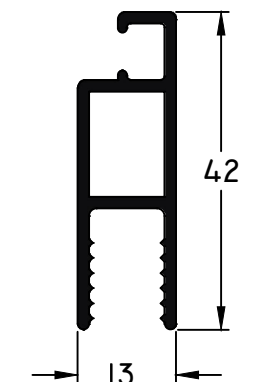

685 - Mosquitero  
peso: 0,38 Kg/m

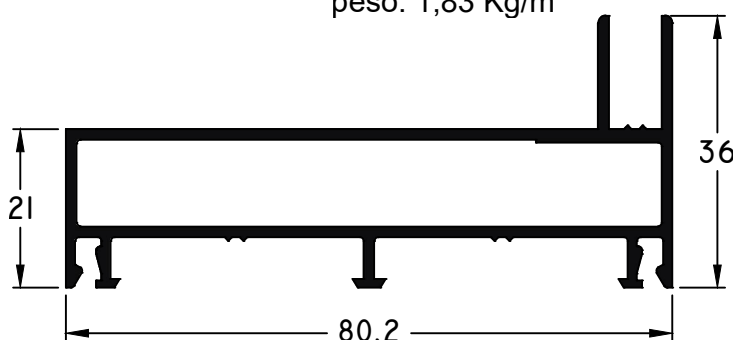

692 - Jamba Marco de 3 Guías  
Largo Std.: 6150 mm  
peso: 0,98 Kg/m

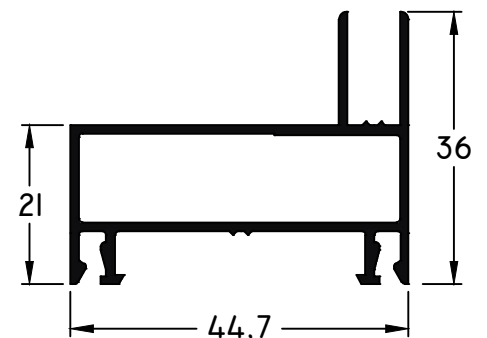

655 - Jamba  
Largo Std.: 6150 mm  
peso: 0,59 Kg/m

Escala 1:1

Tolerancia en Peso +/- 10% Tolerancia largo +10 mm -0 mm

09-06-23 DELTA.5

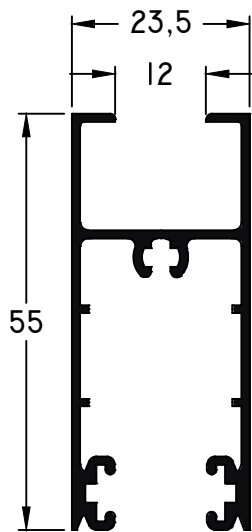

652 - Zócalo  
peso: 0,64 Kg/m

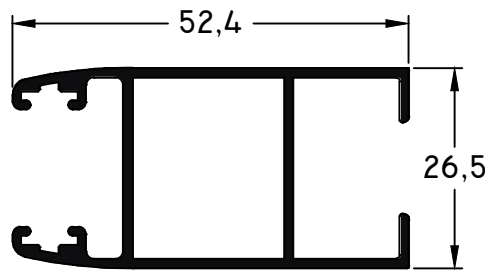

653 - Parante Lateral  
Largo Std.: 6150 mm  
peso: 0,64 Kg/m

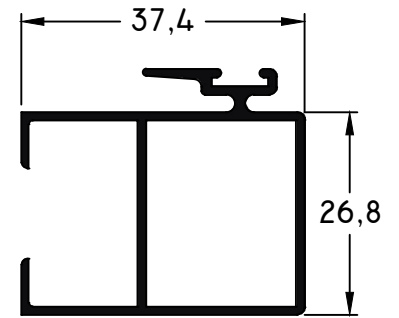

654 - Parante Central  
Largo Std.: 6150 mm  
peso: 0,58 Kg/m

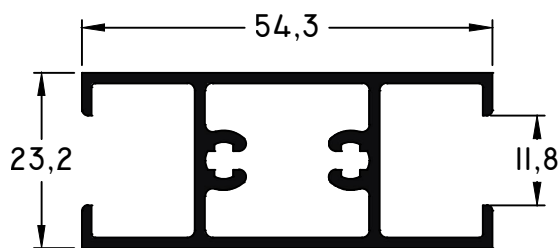

638 - Travesaño  
peso: 0,70 Kg/m

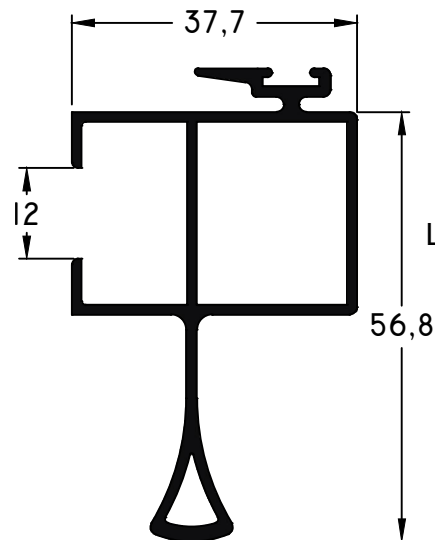

677 - Parante  
Lat. con Tirador  
Largo Std.: 6150 mm  
peso: 0,79 Kg/m

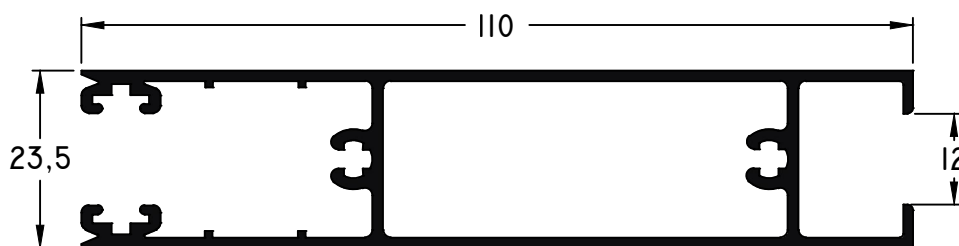

660 - Zócalo Puerta Corrediza  
peso: 1,26 Kg/m

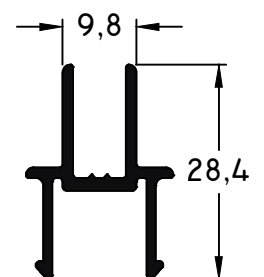

642 - Encuentro de 4 hojas  
peso: 0,29 Kg/m

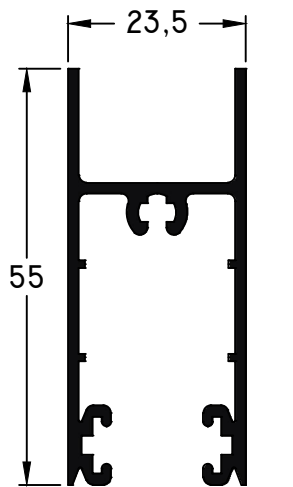

663 - Zócalo D.V.H.  
peso: 0,68 Kg/m

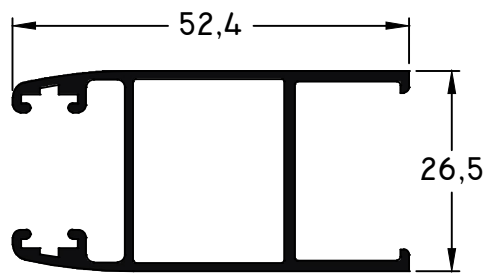

665 - Parante  
Lateral D.V.H.  
Largo Std.: 6150 mm  
peso: 0,59 Kg/m

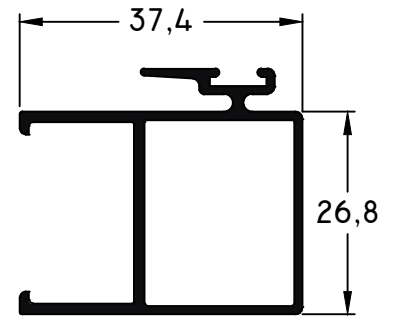

664 - Parante  
Central D.V.H.  
Largo Std.: 6150 mm  
peso: 0,56 Kg/m

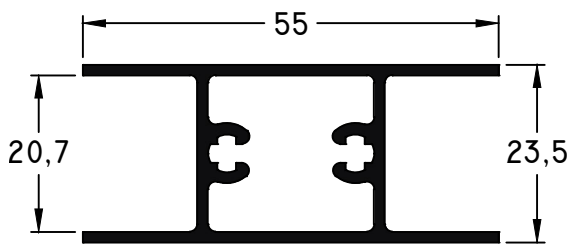

681 - Travesaño D.V.H.  
peso: 0,70 Kg/m

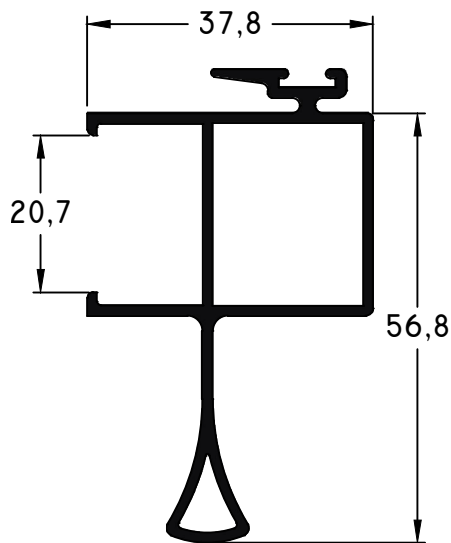

687 - Parante Lat.  
con Tirador D.V.H.  
Largo Std.: 6150 mm  
peso: 0,76 Kg/m

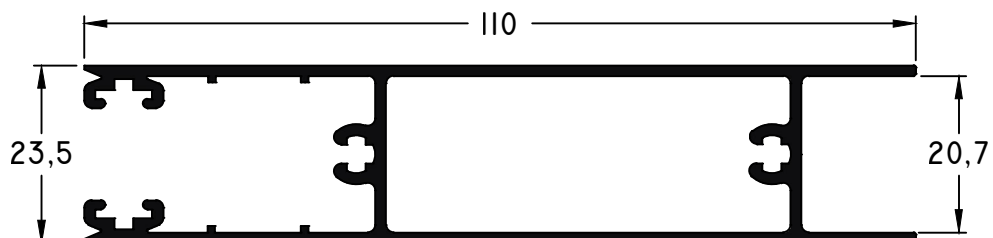

686 - Zócalo Puerta Corrediza D.V.H.  
peso: 1,23 Kg/m



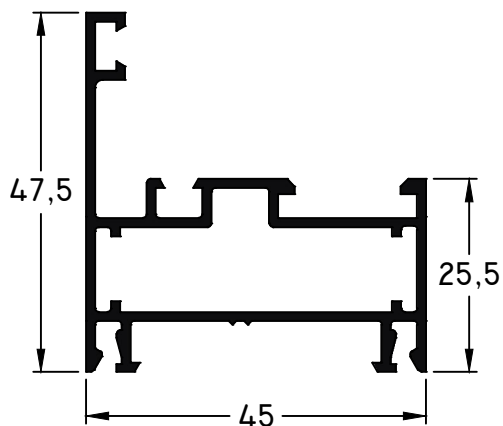

662 - Marco Vent.  
de Abrir CEP  
Largo Std.: 6150 mm  
peso: 0,71 Kg/m

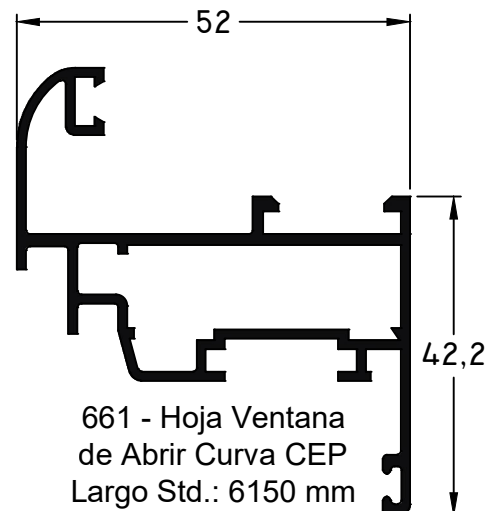

661 - Hoja Ventana  
de Abrir Curva CEP  
Largo Std.: 6150 mm  
peso: 0,79 Kg/m

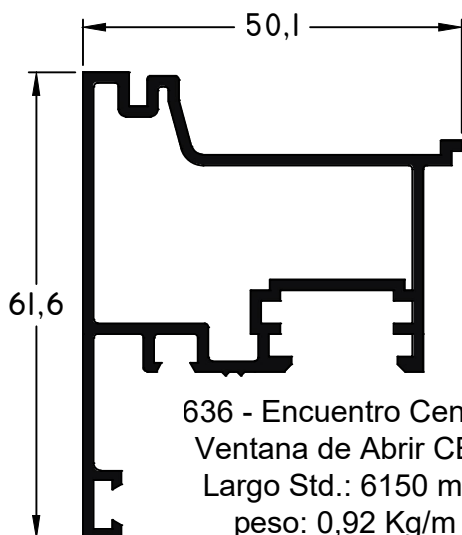

636 - Encuentro Central  
Ventana de Abrir CEP  
Largo Std.: 6150 mm  
peso: 0,92 Kg/m

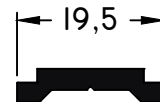

9469 - Perfil Varilla  
de Poliamida  
peso: 0,07 Kg/m

### Paño Fijo Curvo

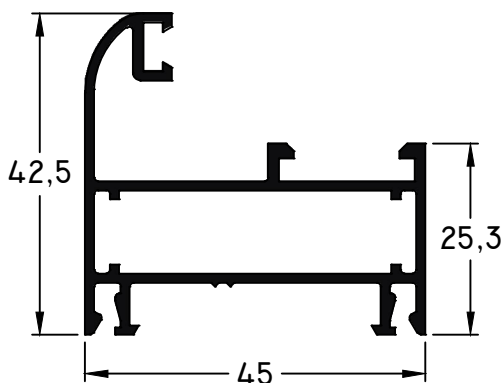

656 - Marco Paño  
Fijo Curvo  
Largo Std.: 6150 mm  
peso: 0,70 Kg/m

Escala 1:1

Tolerancia en Peso +/- 10% Tolerancia largo +10 mm -0 mm

09-06-23 DELTA.8

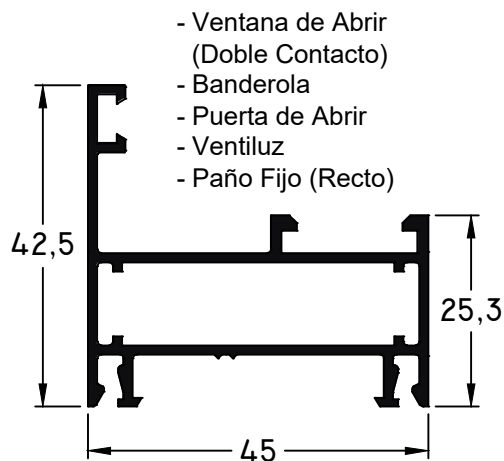

668 - Marco VA/  
VB/PA/VV/PF  
Largo Std.: 6150 mm  
peso: 0,66 Kg/m

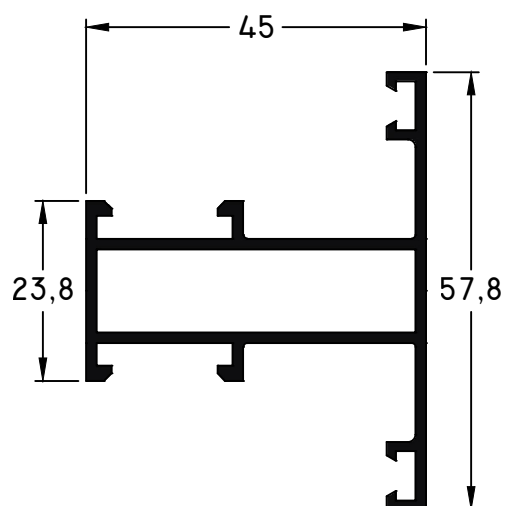

629 - Travesaño Angosto  
Paño Fijo p/Marco 668  
peso: 0,77 Kg/m

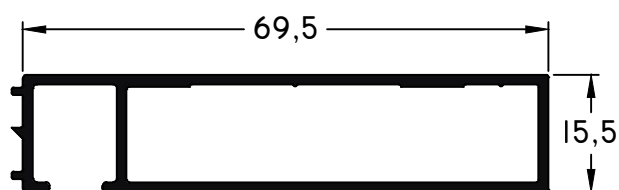

840 - Premarco de 69.5mm  
Largo Std.: 6150 mm  
peso: 0,63 Kg/m

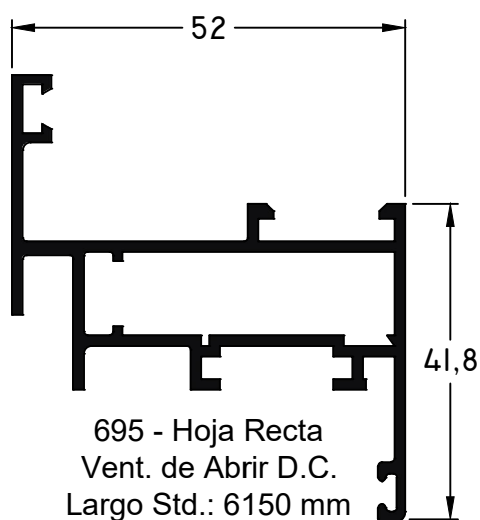

695 - Hoja Recta  
Vent. de Abrir D.C.  
Largo Std.: 6150 mm  
peso: 0,86 Kg/m

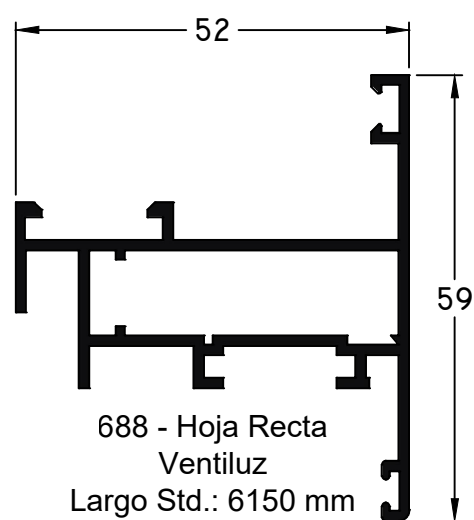

688 - Hoja Recta  
Ventiluz  
Largo Std.: 6150 mm  
peso: 0,85 Kg/m

Escala 1:1

Tolerancia en Peso +/- 10% Tolerancia largo +10 mm -0 mm

09-06-23 DELTA.9

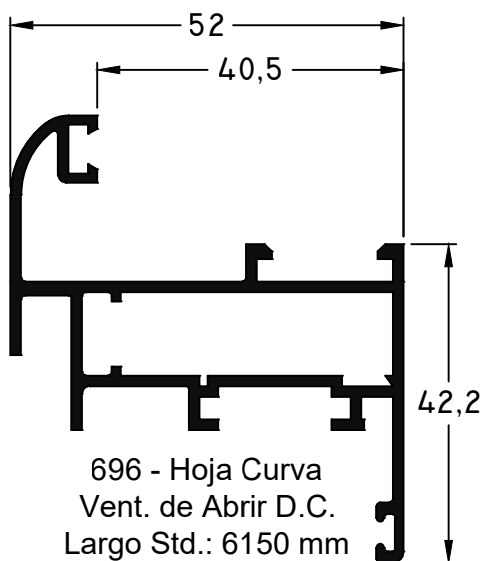

696 - Hoja Curva  
Vent. de Abrir D.C.  
Largo Std.: 6150 mm  
peso: 0,90 Kg/m

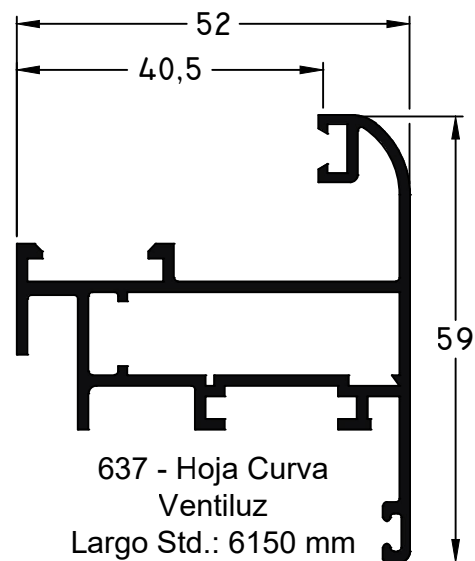

637 - Hoja Curva  
Ventiluz  
Largo Std.: 6150 mm  
peso: 0,90 Kg/m

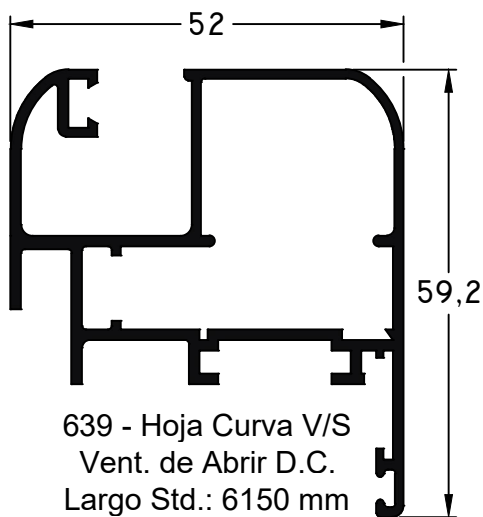

639 - Hoja Curva V/S  
Vent. de Abrir D.C.  
Largo Std.: 6150 mm  
peso: 0,99 Kg/m

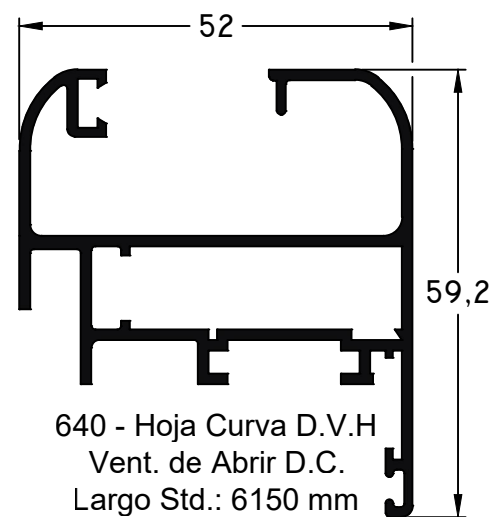

640 - Hoja Curva D.V.H  
Vent. de Abrir D.C.  
Largo Std.: 6150 mm  
peso: 1,00 Kg/m

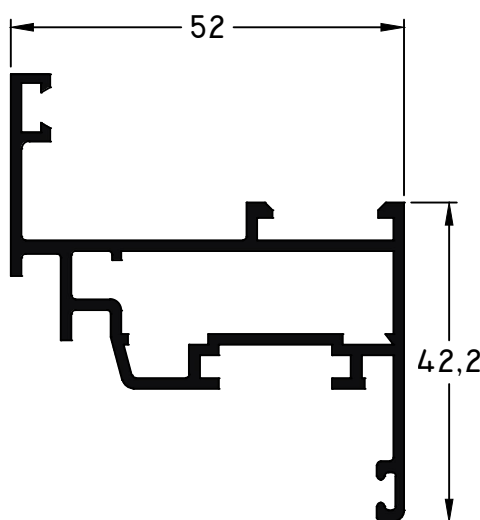

635 - Hoja de Abrir Camara  
compensadora  
peso: 0,91 Kg/m

Escala 1:1

Tolerancia en Peso +/- 10% Tolerancia largo +10 mm -0 mm

09-06-23 DELTA.10

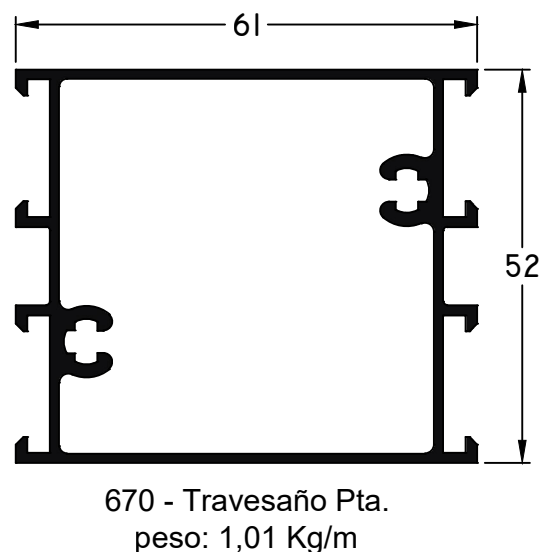
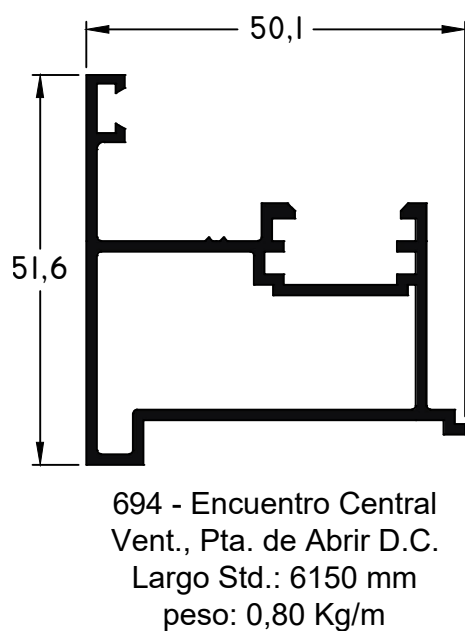
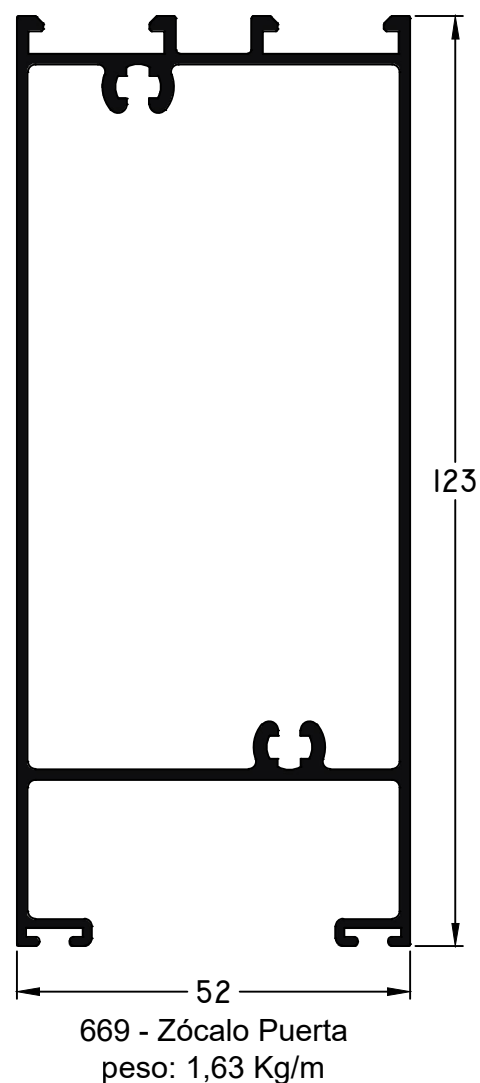
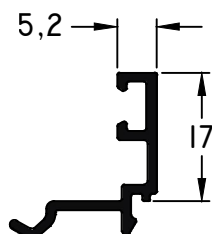
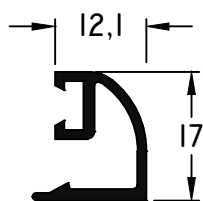
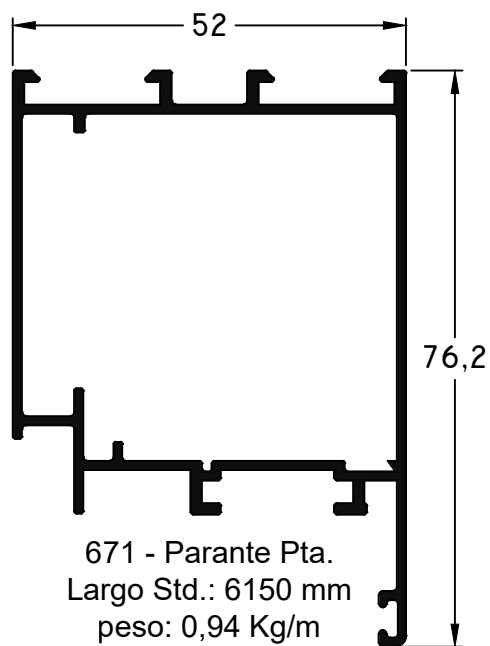

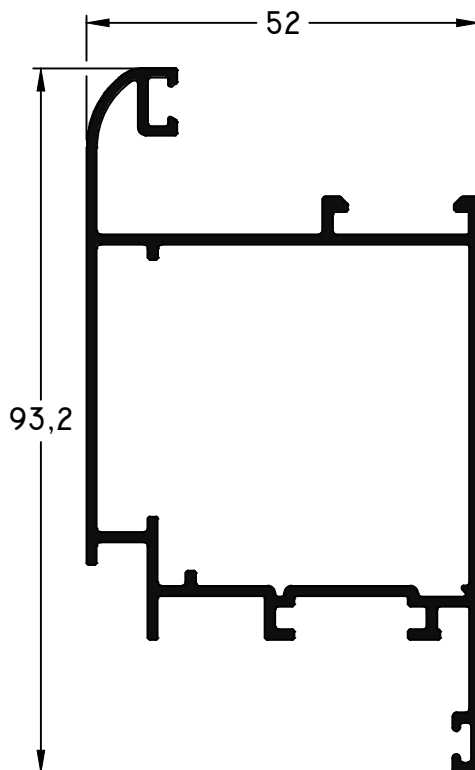

614 - Hoja de Puerta sin  
Contravidrio Exterior  
peso: 1,15 Kg/m

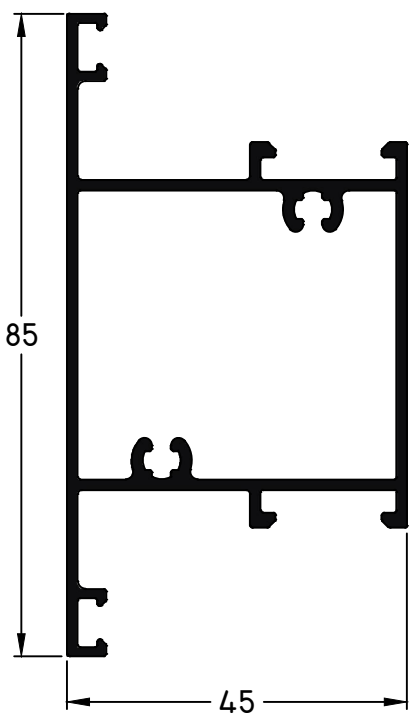

615 - Travesaño de Puerta sin  
Contravidrio Exterior  
peso: 1,09 Kg/m

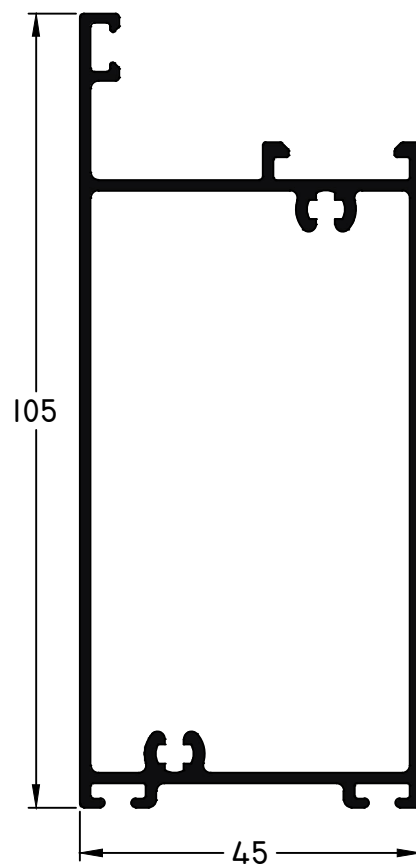

616 - Zócalo de Puerta sin  
Contravidrio Exterior  
peso: 1,29 Kg/m

Escala 1:1

Tolerancia en Peso +/- 10% Tolerancia largo +10 mm -0 mm

09-06-23 DELTA.12

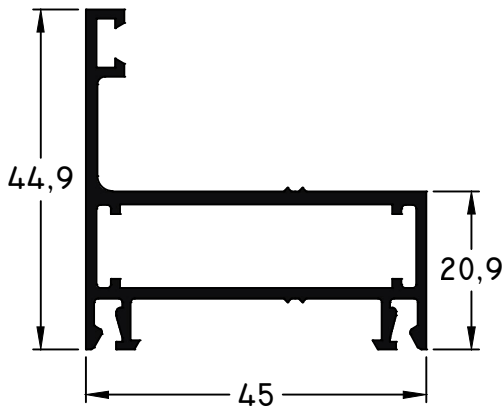

676 - Marco Vent.  
 Projectante  
 Largo Std.: 6150 mm  
 peso: 0,72 Kg/m

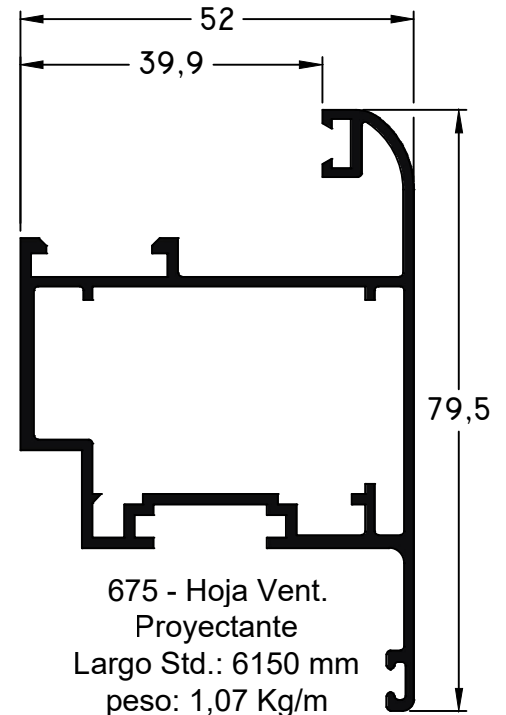

675 - Hoja Vent.  
 Projectante  
 Largo Std.: 6150 mm  
 peso: 1,07 Kg/m

## Contra vidrios

	690 - Contra vidrio Curvo 8 mm. peso: 0,14 Kg/m		645 - Contra vidrio Recto 15 mm. peso: 0,21 Kg/m
	666 - Contra vidrio Curvo 15 mm. peso: 0,16 Kg/m		633 - Contra vidrio Recto 22 mm. peso: 0,26 Kg/m
	680 - Contra vidrio Curvo 22 mm. peso: 0,18 Kg/m		646 - Contra vidrio Recto 29 mm. peso: 0,29 Kg/m
	667 - Contra vidrio Curvo 29 mm. peso: 0,21 Kg/m largo: 6030 mm		632 - Contra vidrio Recto 36 mm. peso: 0,32 Kg/m
	689 - Contra vidrio Curvo 36 mm. peso: 0,24 Kg/m		

Escala 1:1

Tolerancia en Peso +/- 10% Tolerancia largo +10 mm -0 mm

09-06-23 DELTA.13

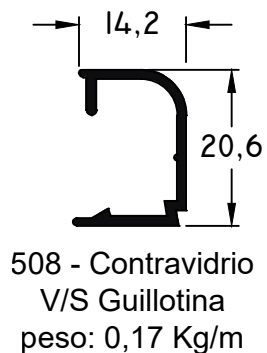
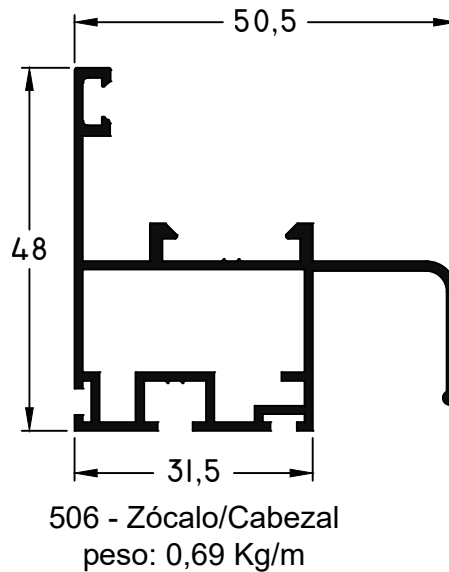
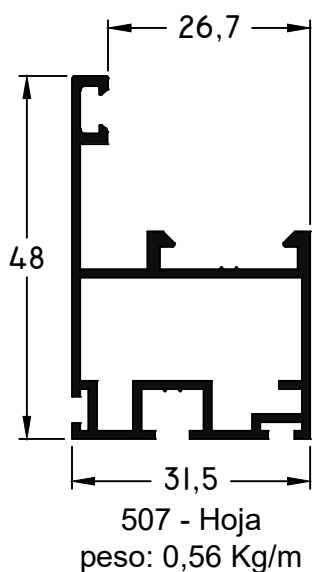
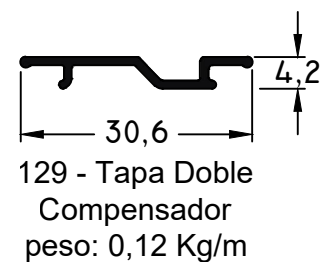
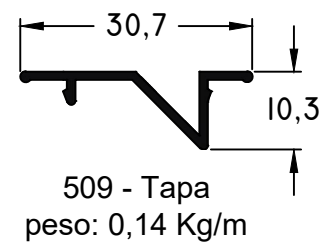
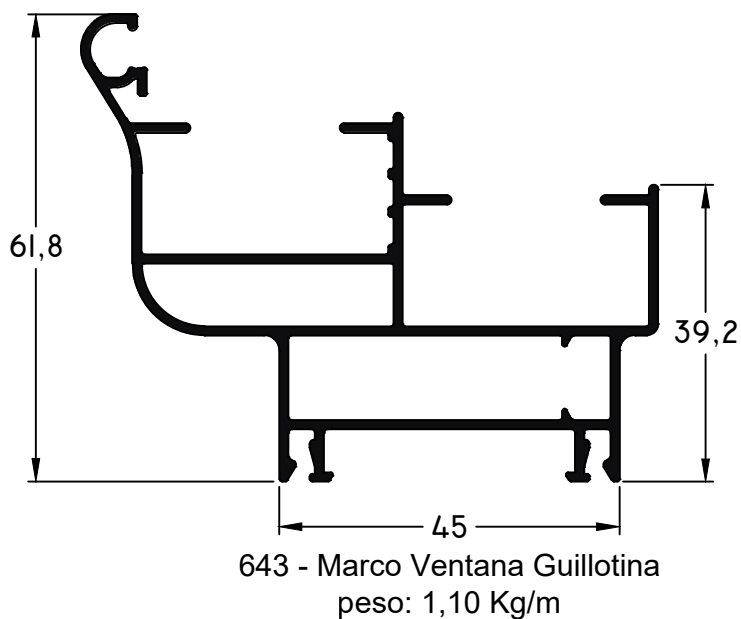

## Premarco, Contramarco y Guías de Cortinas

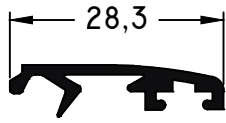

657 - Contramarco  
Largo Std.: 6150 mm  
peso: 0,19 Kg/m

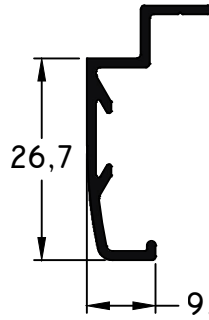

863 - Contramarco de atornillar  
Largo Std.: 6150 mm  
peso: 0,21 Kg/m

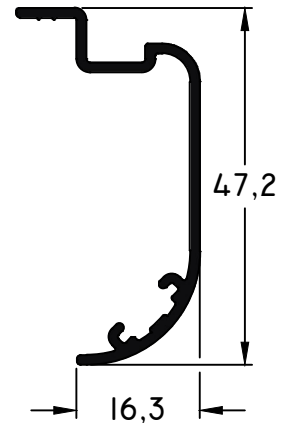

641 - Contramarco  
Largo Std.: 6150 mm  
peso: 0,32 Kg/m

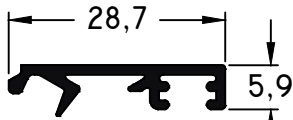

649 - Contramarco recto  
Largo Std.: 6150 mm  
peso: 0,19 Kg/m

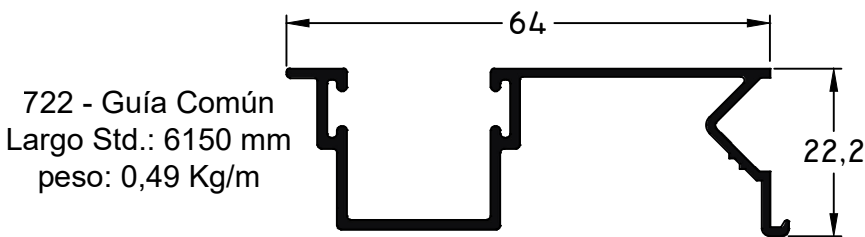

722 - Guía Común  
Largo Std.: 6150 mm  
peso: 0,49 Kg/m

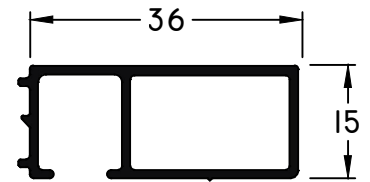

718 - Premarco  
Largo Std.: 6150 mm  
peso: 0,33 Kg/m

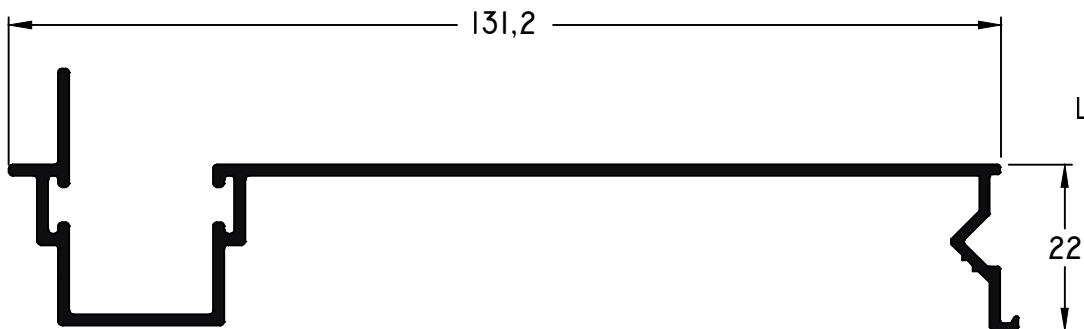

684 - Guía Barrio  
Largo Std.: 6150 mm  
peso: 0,89 Kg/m

## Tapacinta

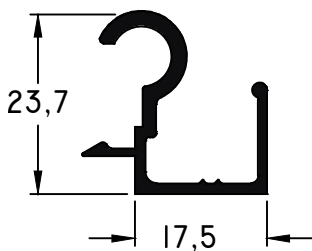

682 - Bisagra  
Tapacinta  
Largo Std.: 6150 mm  
peso: 0,27 Kg/m

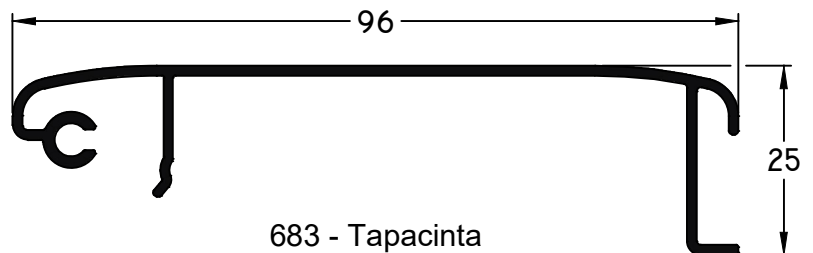

683 - Tapacinta  
Largo Std.: 6150 mm  
peso: 0,60 Kg/m

Escala 1:1

Tolerancia en Peso +/- 10% Tolerancia largo +10 mm -0 mm

09-06-23 DELTA.15



## Columnas y Acoples

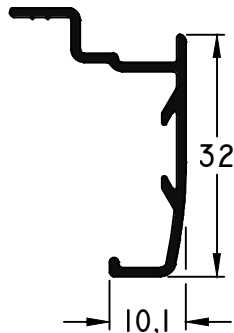

151 - Contramarco de atornillar  
 Largo std.: 6150 mm  
 Peso: 0,24 Kg/m

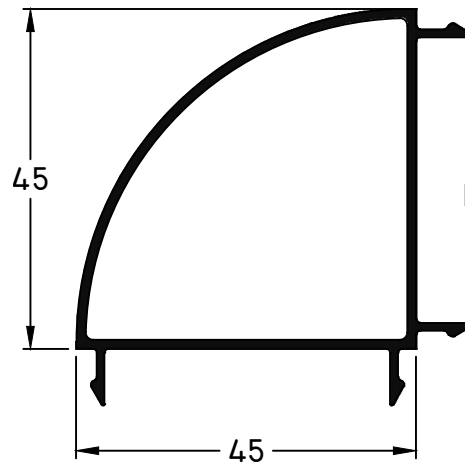

658 - Columna  
 Curva a 90°  
 Largo Std.: 6150 mm  
 peso: 0,68 Kg/m

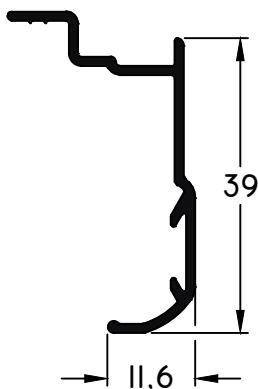

152 - Contramarco de atornillar  
 Largo std.: 6150 mm  
 Peso: 0,26 Kg/m

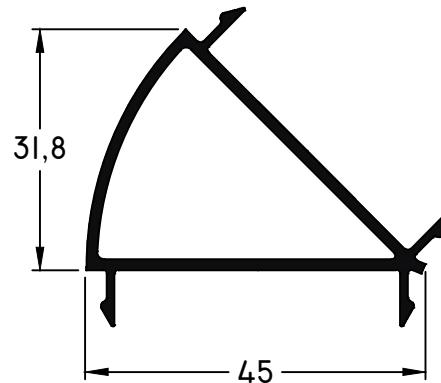

659 - Columna  
 Curva a 45°  
 Largo Std.: 6150 mm  
 peso: 0,54 Kg/m

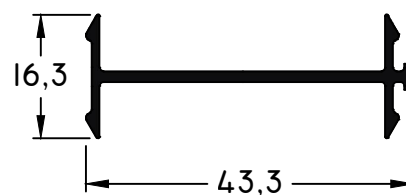

720 - Acople  
 Largo Std.: 6150 mm  
 peso: 0,26 Kg/m

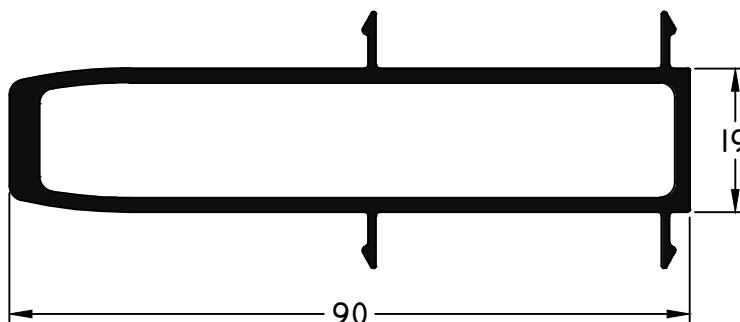

634 - Acople  
 Columna Reforzado  
 Largo Std.: 6150 mm  
 peso: 1,24 Kg/m

Escala 1:1

Tolerancia en Peso +/- 10% Tolerancia largo +10 mm -0 mm

09-06-23 DELTA.16

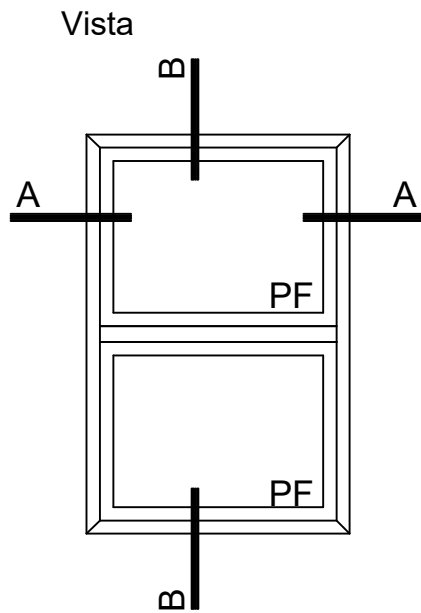

B-B Corte Vertical

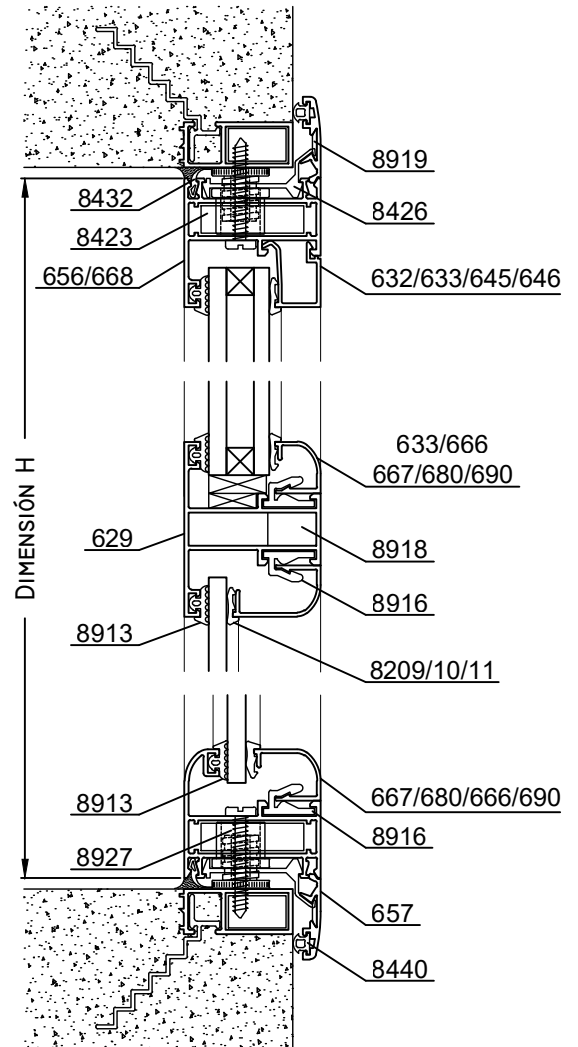

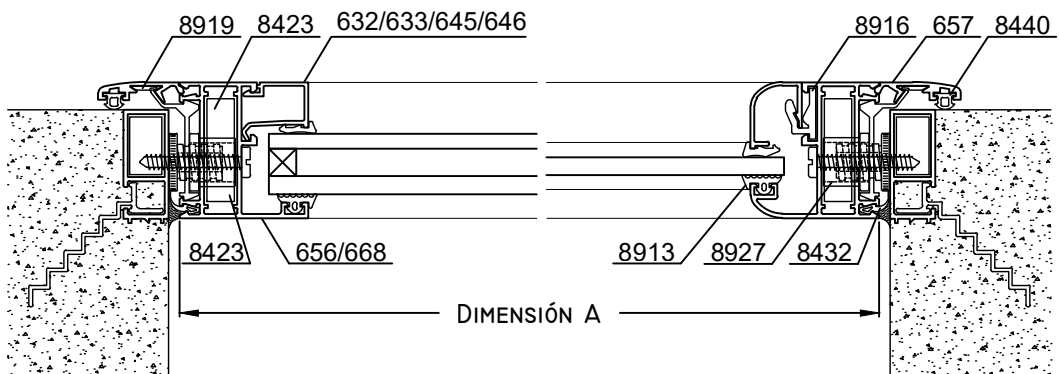

A - A Corte Horizontal



Escala 1:2.5

Tolerancia en Peso +/- 10% Tolerancia largo +10 mm -0 mm





09-06-23 DELTA.17



Dimensiones de Corte Paño Fijo						
Función	Código	Peso Kg/m	Forma	Cant.	Largo	Corte
Marco	668	0,66		2	a	45° 45°
				2	H	45° 45°
	656	0,70		2	a	45° 45°
				2	H	45° 45°
Contravidrio	Contravidrios Curvos	-	-	2	a-51	45° 45°
				2	H-51	45° 45°
	Contravidrios Rectos	-	-	2	a-51	90° 90°
				2	H-85	90° 90°
Travesaño	629	0,77		-	(AoH)-51	90° 90°

- El Perfil de Travesaño 629, sólo puede ser utilizado con el Perfil de Marco 668.

- Medidas en milímetros

- Dimensiones de Corte de Premarco y Contramarco, en página 55

Detalle de Accesorios Paño Fijo			
Código	Descripción	Forma	Cantidad
8423	Escuadra de Armado E-69		4 Unidades
8916	Clip Contravidrio T-96		s/m
8913	Burlete de Acristalamiento B-68		2A + 2H
8209	Cuña Chica		2A + 2H
8210	Cuña Mediana		
8211	Cuña Grande		

Accesorios Travesaño			
Código	Descripción	Forma	Cantidad
8918	Fijador Travesaño E-71		2 U. x Trav.
8913	Burlete de Acristalamiento B-68		2A
8209	Cuña Chica		2A
8210	Cuña Mediana		
8211	Cuña Grande		

- Detalle de Accesorios para Fijación, Premarco y Contramarco en página 55

- s/m : según medida

Vista

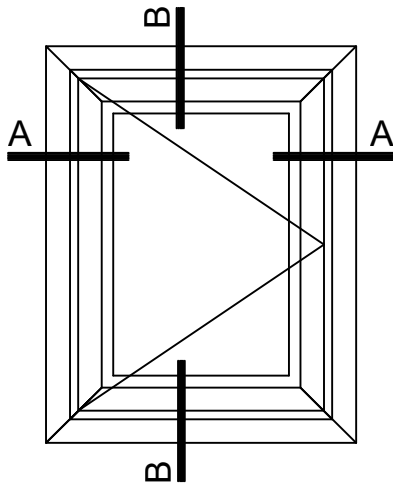

B-B Corte Vertical

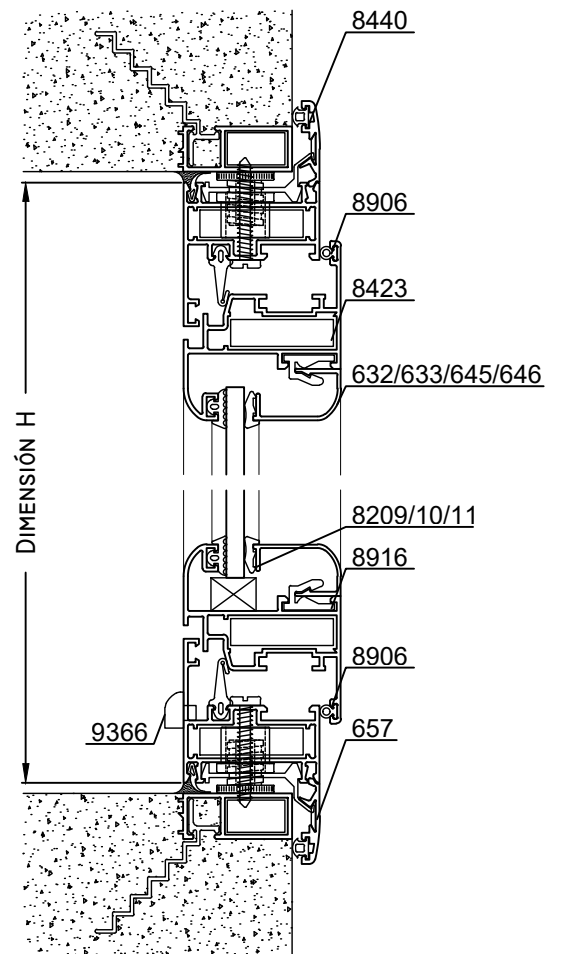

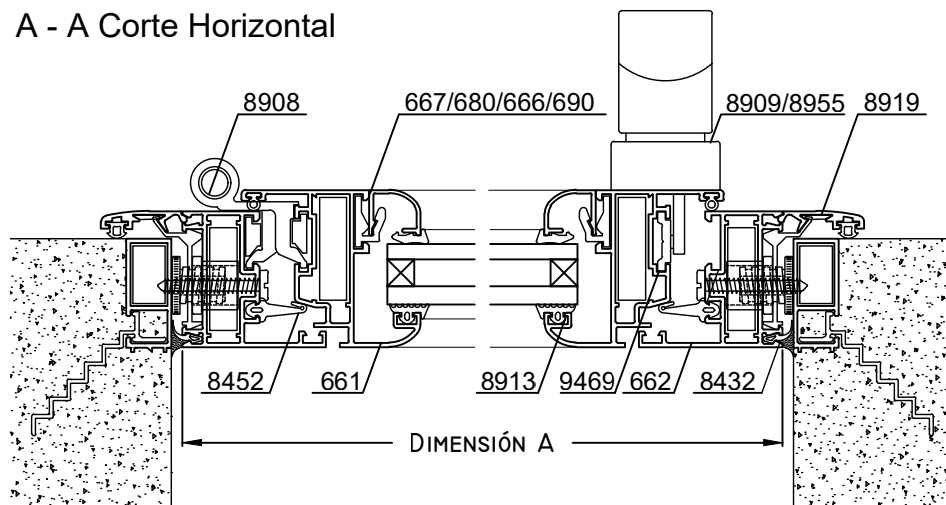

A - A Corte Horizontal



Escala 1:2.5

Tolerancia en Peso +/- 10% Tolerancia largo +10 mm -0 mm

09-06-23 DELTA.19

Dimensiones de Corte Ventana de Rebatir de 1 Hoja						
Función	Código	Peso Kg/m	Forma	Cant.	Largo	Corte
Marco	662	0,71		2	A	45° 45°
				2	H	45° 45°
Hoja	661	0,79		2	A-39	45° 45°
				2	H-39	45° 45°
Varilla	9469	0,16		2	S/F	90° 90°
Contravidrio	Contravidrios Curvos	-	-	2	A-123	45° 45°
				2	H-123	45° 45°
	Contravidrios Rectos	-	-	2	A-123	90° 90°
				2	H-157	90° 90°

- Medidas en milímetros
- S/F: Corte según Falleba
- Dimensiones de Corte de Premarco y Contramarco, en página 55

Detalle de Accesorios Ventana de Rebatir de 1 Hoja			
Código	Descripción	Forma	Cantidad
8423	Escuadra de Armado E-69		8 Unidades
8916	Clip Contravidrio T-96		s/m
8913	Burlete de Acristalamiento B-68		2A + 2H
8209	Cuña Chica		2A + 2H
8210	Cuña Mediana		
8211	Cuña Grande		
8906	Burlete AEL Europeo		2A + 2H
8452	Burlete de Hermetic. Cámara Compensada		2A + 2H
8909	Falleba Euro H-48 con Kit		1 Unidad
8955	Falleba Nova H-86 con Kit		
8909	Falleba Prima H-47 con Kit		
8912	Traba Varilla Simple H-43		2 Unidades
8433	Sostén de hoja H-44	-	1 Unidades
8908	Bisagra H-61 de 2 piezas con Kit		2 Unidades
8366	Tapa Desague T-69		2 Unidades

- Detalle de Accesorios para Fijación, Premarco y Contramarco en página 55
- s/m : según medida

Vista

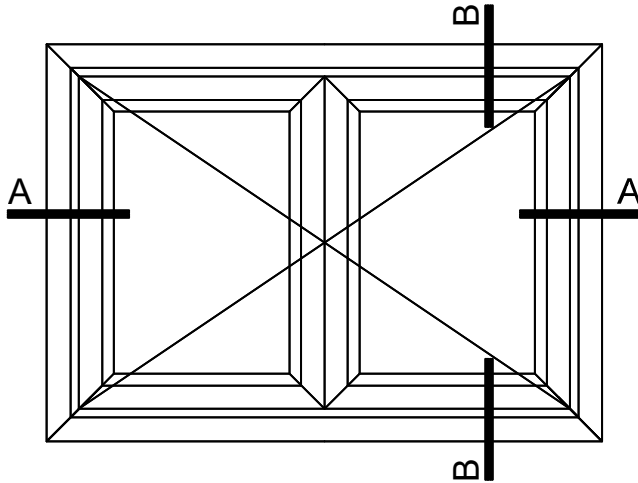

B-B Corte Vertical

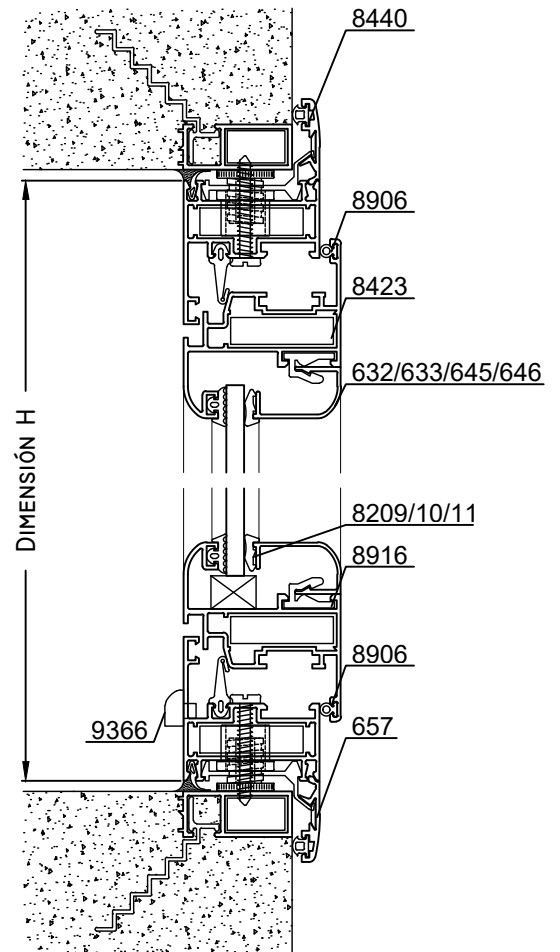



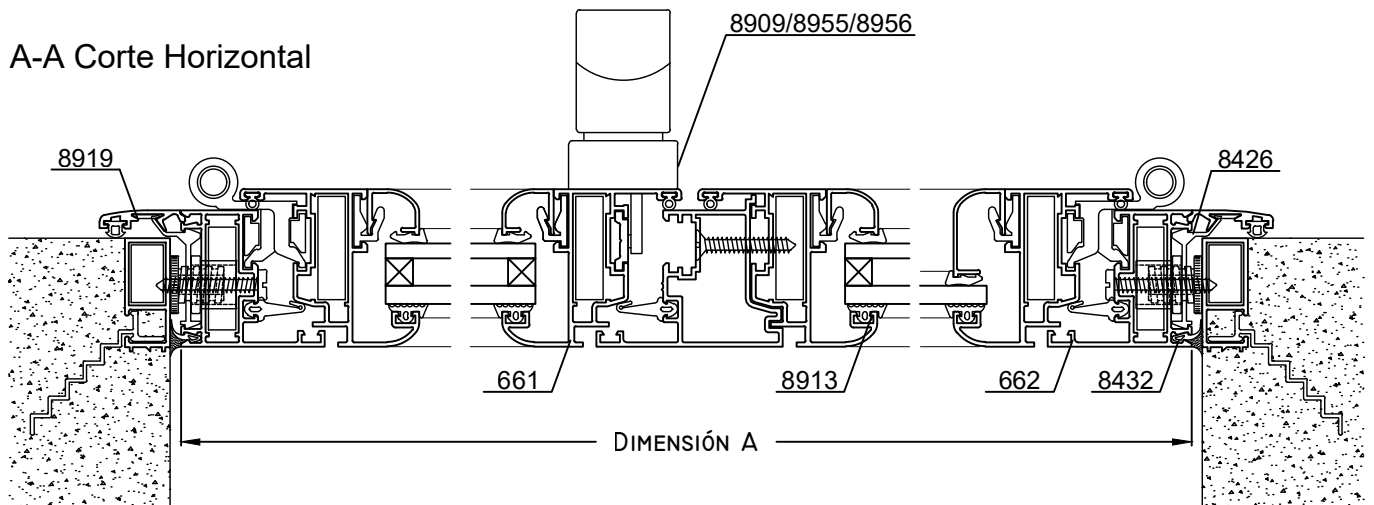

A-A Corte Horizontal



Escala 1:2.5

Tolerancia en Peso +/- 10% Tolerancia largo +10 mm -0 mm



09-06-23 DELTA.21

Dimensiones de Corte Ventana de Rebatir de 2 Hojas						
Función	Código	Peso Kg/m	Forma	Cant.	Largo	Corte
Marco	662	0,71		2	A	45° 45°
				2	H	45° 45°
Hoja	661	0,79		4	A/2-23	45° 45°
				4	H-39	45° 45°
Inversor	636	0,92		1	H-104	90° 90°
Varilla	9469	0,16		2	S/F	90° 90°
Contra Vidrio	Contra vidrios Curvos	-	-	4	A/2-107	45° 45°
				4	H-123	45° 45°
	Contra vidrios Rectos	-	-	4	A/2-107	90° 90°
				4	H-157	90° 90°

- Medidas en milímetros
- S/F: Corte según Falleba
- Dimensiones de Corte de Premarco y Contramarco, en página 55









Detalle de Accesorios Ventana de Rebatir de 2 hojas			
Código	Descripción	Forma	Cantidad
8423	Escuadra de Armado E-69		12 Unidades
-	Tornillo Parker 8 x 1½ T-15/F		s/m
8916	Clip Contra Vidrio T-96		s/m
8913	Burlete de Acristalamiento B-68		2A + 4H
8209	Cuña Chica		2A + 4H
8210	Cuña Mediana		
8211	Cuña Grande		
8906	Burlete AEL Europeo		2A + 3H
8452	Burlete de Hermetic. Cámara Compensada		2A + 3H
8909	Falleba Euro H-48 con Kit		1 Unidad
8955	Falleba Nova H-86 con Kit		
8909	Falleba Prima H-47 con Kit		
8912	Traba Varilla Simple H-43		2 Unidades
8908	Bisagra H-61 de 2 piezas con Kit		4 Unidades
8910	Pasador Chiudo H-49		2 Unidades
8433	Sostén de hoja H-44	-	2 Unidades
8450	Tapón Encuentro 2 Hojas T-97		2 Unidades
8366	Tapa Desague T-69		2 Unidades

- Detalle de Accesorios para Fijación, Premarco y Contramarco en página 55
- s/m : según medida

Dimensiones de Corte Ventana Oscilo-Batiente de 1 Hoja						
Función	Código	Peso Kg/m	Forma	Cant.	Largo	Corte
Marco	662	0,71		2	A	45° 45°
				2	H	45° 45°
Hoja	661	0,79		2	A-39	45° 45°
				2	H-39	45° 45°
Varilla	9469	0,16		2	Ver pág. 48	90° 90°
Contravidrio	Contravidrios Curvos	-	-	2	A-123	45° 45°
				2	H-123	45° 45°
	Contravidrios Rectos	-	-	2	A-123	90° 90°
				2	H-157	90° 90°

- Medidas en milímetros





- Dimensiones de Corte de Premarco y Contramarco, en página 55

Detalle de Accesorios Ventana Oscilo-Batiente de 1 hoja			
Código	Descripción	Forma	Cantidad
8423	Escuadra de Armado E-69		8 Unidades
8916	Clip Contravidrio T-96		s/m
8913	Burlete de Acristalamiento B-68		2A + 2H
8209	Cuña Chica		2A + 2H
8210	Cuña Mediana		
8211	Cuña Grande		
8906	Burlete AEL Europeo		2A + 2H
8452	Burlete de Hermetic. Cámara Compensada		2A + 2H
9205	Falleba Euro o Prima para Oscilo-Batiente	-	1 Unidad
9206	Mecanismo OB para hoja de hasta 80 kg.	-	1 Unidad
9207	Brazo Tipo I (Ancho Hoja 375 a 530 m/m.)	-	1 Unidad
9208	Brazo Tipo II (Ancho Hoja 531 a 1700 m/m.)		
9209	Comp. Sup. (Ancho Hoja 1100 a 1700 m/m.)	-	Ver pág. 56
9210	Cierre Sup. (Alto Hoja superior a 1200 m/m. / Ancho Hoja superior a 1000 m/m.)	-	Ver pág. 56
8912	Traba Varilla Simple H-43		2 Unidades
8366	Tapa Desague T-69		2 Unidades

- Detalle de Accesorios para Fijación, Premarco y Contramarco en página 55

- s/m : según medida



Dimensiones de Corte Ventana Oscilo-Batiente de 2 Hojas						
Función	Código	Peso Kg/m	Forma	Cant.	Largo	Corte
Marco	662	0,71		2	A	45° 45°
				2	H	45° 45°
Hoja	661	0,79		4	A/2-23	45° 45°
				4	H-39	45° 45°
Inversor	636	0,92		1	H-94	90° 90°
Varilla	9469	0,07		2	Ver pág. 48	90° 90°
Contravidrio	Contravidrios Curvos	-	-	4	A/2-106	45° 45°
				4	H-123	45° 45°
	Contravidrios Rectos	-	-	4	A/2-106	90° 90°
				4	H-157	90° 90°

- Medidas en milímetros  
- Dimensiones de Corte de Premarco y Contramarco, en página 55

Detalle de Accesorios Ventana Oscilo-Batiente de 2 hojas			
Código	Descripción	Forma	Cantidad
8423	Escuadra de Armado E-69		12 Unidades
-	Tornillo Parker 8 x 1½ T-15/F		s/m
8916	Clip Contravidrio T-96		s/m
8913	Burlete de Acristalamiento B-68		2A + 4H
8209	Cuña Chica		2A + 4H
8210	Cuña Mediana		
8211	Cuña Grande		
8906	Burlete AEL Europeo		2A + 3H
8452	Burlete de Hermetic. Cámara Compensada		2A + 3H
9205	Falleba Euro o Prima para Oscilo-Batiente	-	1 Unidad
9206	Mecanismo OB para hoja de hasta 80 kg.	-	1 Unidad
9207	Brazo Tipo I (Ancho Hoja 375 a 530 m/m.)	-	1 Unidad
9208	Brazo Tipo II (Ancho Hoja 531 a 1700 m/m.)		
9209	Comp. Sup. (Ancho Hoja 1100 a 1700 m/m.)	-	Ver pág. 56
9210	Cierre Sup. (Alto Hoja superior a 1200 m/m. / Ancho Hoja superior a 1000 m/m.)	-	Ver pág. 56
9212	Pasador para Hoja Pasiva H-83	-	2 Unidades
8908	Bisagra H-61 de 2 piezas con Kit		2 Unidades
8910	Pasador Chiudo H-49		2 Unidades
8451	Tapón Encuentro 2 Hojas T-98		2 Unidades
8366	Tapa Desague T-69		2 Unidades

- Detalle de Accesorios para Fijación, Premarco y Contramarco en página 55  
- s/m : según medida

Vista

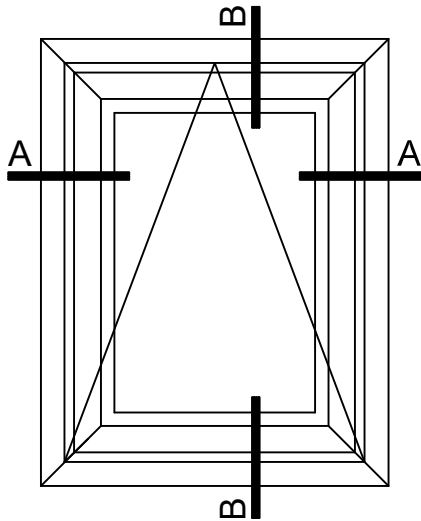

B-B Corte Vertical

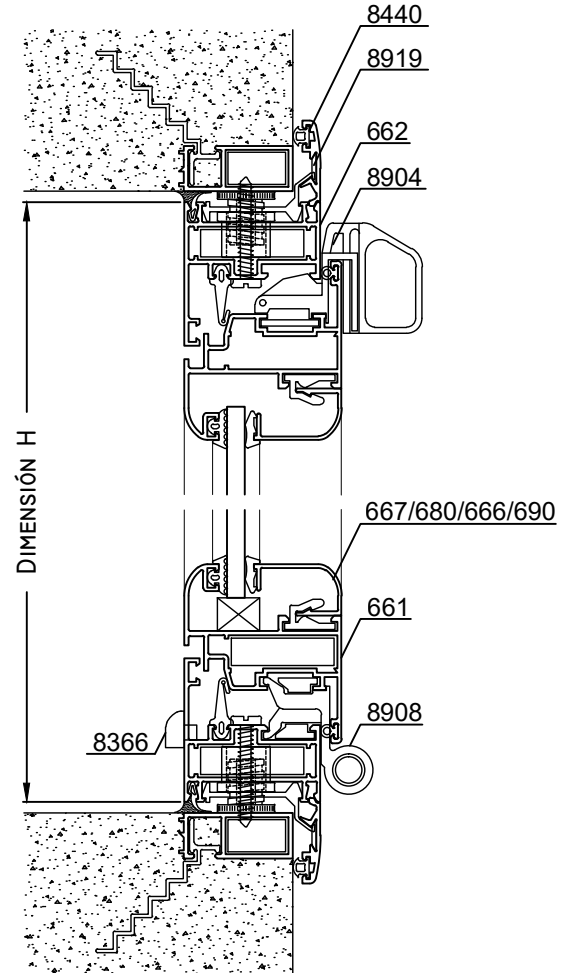

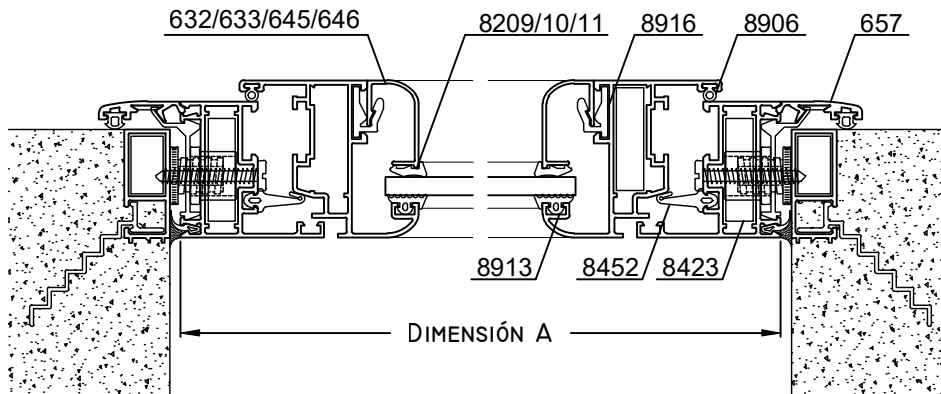

A-A Corte Horizontal



Escala 1:2.5









Tolerancia en Peso +/- 10% Tolerancia largo +10 mm -0 mm

09-06-23 DELTA.25

Dimensiones de Corte Ventana Banderola						
Función	Código	Peso Kg/m	Forma	Cant.	Largo	Corte
Marco	662	0,71		2	A	45° 45°
				2	H	45° 45°
Hoja	661	0,79		2	A-39	45° 45°
				2	H-39	45° 45°
Contravidrio	Contravidrios Curvos	-	-	2	A-123	45° 45°
				2	H-123	45° 45°
	Contravidrios Rectos	-	-	2	A-123	90° 90°
				2	H-157	90° 90°

- Medidas en milímetros

- Dimensiones de Corte de Premarco y Contramarco, en página 55

Detalle de Accesorios Ventana Banderola			
Código	Descripción	Forma	Cantidad
8423	Escuadra de Armado E-69		8 Unidades
8916	Clip Contravidrio T-96		s/m
8913	Burlete de Acristalamiento B-68		2A + 2H
8209	Cuña Chica		2A + 2H
8210	Cuña Mediana		
8211	Cuña Grande		
8906	Burlete AEL Europeo		2A + 2H
8452	Burlete de Hermetic. Cámara Compensada		2A + 2H
8904	Cierre Banderola H-52		1 Unidad(*)
8443	Brazo Sostén H-53		1 Par
8908	Bisagra H-61 de 2 piezas con Kit		2 Unidades
8366	Tapa Desague T-69		2 Unidades

- Detalle de Accesorios para Fijación, Premarco y Contramarco en página 55

- s/m : según medida

(\*) En hojas de medidas superiores a 800mm de ancho se aconseja colocar 2 cierres

Vista

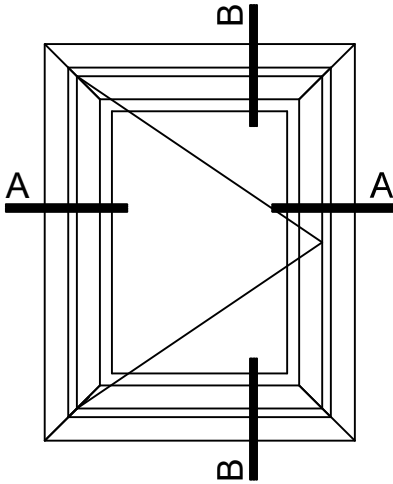

Nota:

Los Contravidrios 689 y 632 son compatibles sólo con la Hoja 695

B-B Corte Vertical

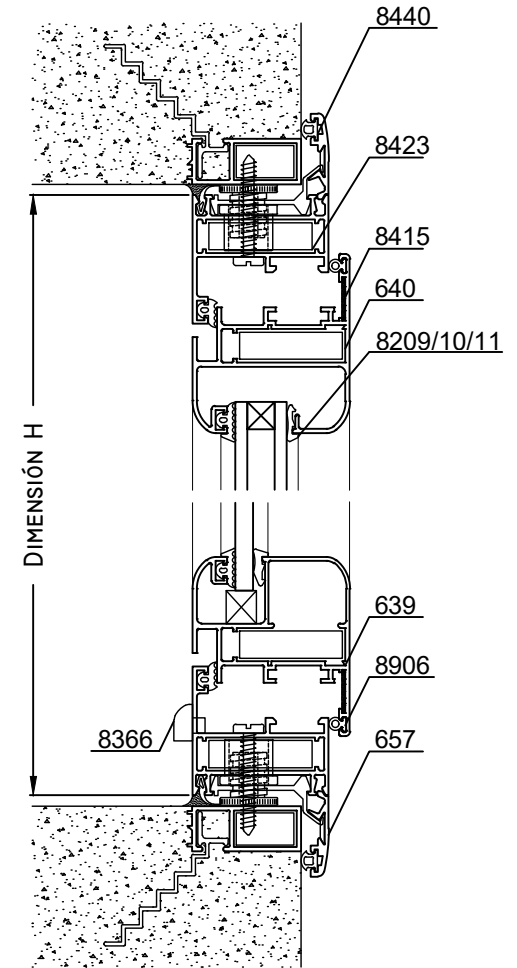

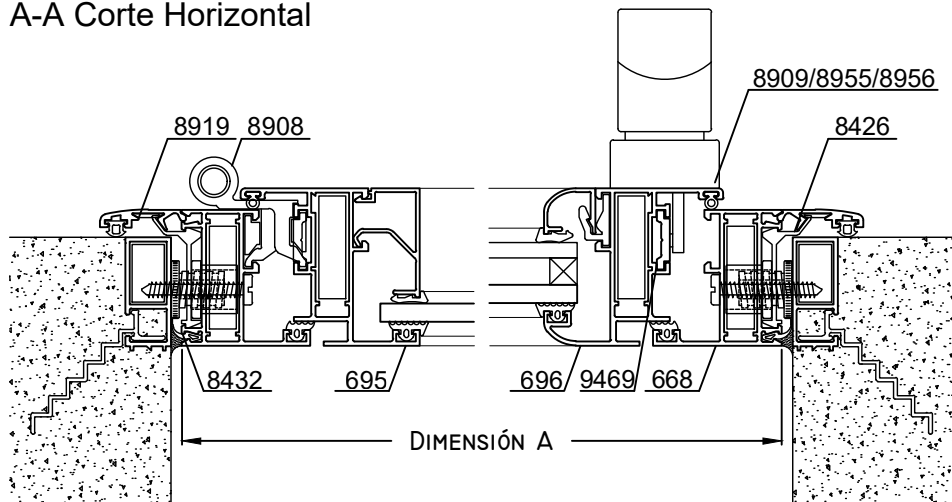

A-A Corte Horizontal



Escala 1:2.5

Tolerancia en Peso +/- 10% Tolerancia largo +10 mm -0 mm

09-06-23 DELTA.27

Dimensiones de Corte Ventana de Rebatir de 1 Hoja						
Función	Código	Peso Kg/m	Forma	Cant.	Largo	Corte
Marco	668	0,66		2	A	45° 45°
				2	H	45° 45°
Hoja	695	0,86	-	2	A-39	45° 45°
	696	0,90		2	H-39	45° 45°
	639	0,99		2	A-39	45° 45°
	640	1,00		2	H-39	45° 45°
Varilla	9469	0,16		2	S/F	90° 90°
Contravidrio	Contravidrios Curvos	-	-	2	A-123	45° 45°
				2	H-123	45° 45°
	Contravidrios Rectos	-	-	2	A-123	90° 90°
				2	H-157	90° 90°

- Medidas en milímetros
- S/F: Corte según Falleba
- Dimensiones de Corte de Premarco y Contramarco, en página 55

Detalle de Accesorios Ventana de Rebatir de 1 Hoja			
Código	Descripción	Forma	Cantidad
8423	Escuadra de Armado E-69		8 Unidades
8415	Escuadra Alineación de Hoja (a)	-	8 Unidades
8916	Clip Contravidrio T-96		s/m
8913	Burlete de Acristalamiento B-68		2A + 2H
8209	Cuña Chica		2A + 2H
8210	Cuña Mediana		
8211	Cuña Grande		
8906	Burlete AEL Europeo		2A + 2H
8914	Burlete de Hermeticidad B-67		2A + 2H
8909	Falleba Euro H-48 con Kit		1 Unidad
8955	Falleba Nova H-86 con Kit		
8909	Falleba Prima H-47 con Kit		
8908	Bisagra H-61 de 2 piezas con Kit		2 Unidades
8366	Tapa Desague T-69		2 Unidades

- Detalle de Accesorios para Fijación, Premarco y Contramarco en página 55
- s/m : según medida
- a: Escuadra de alineación para Hoja 639 y 640

Vista

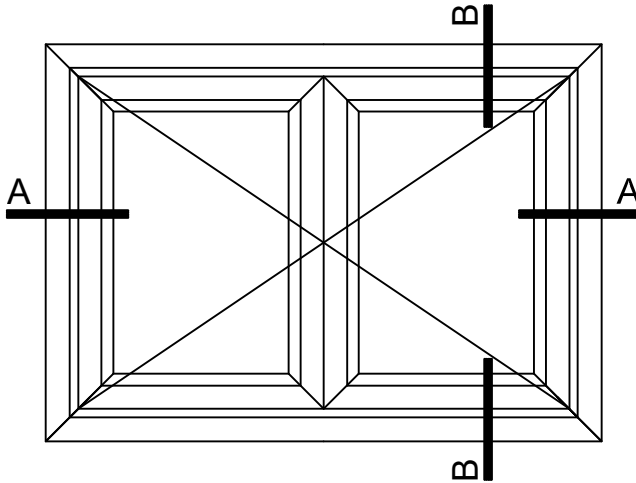

B-B Corte Vertical

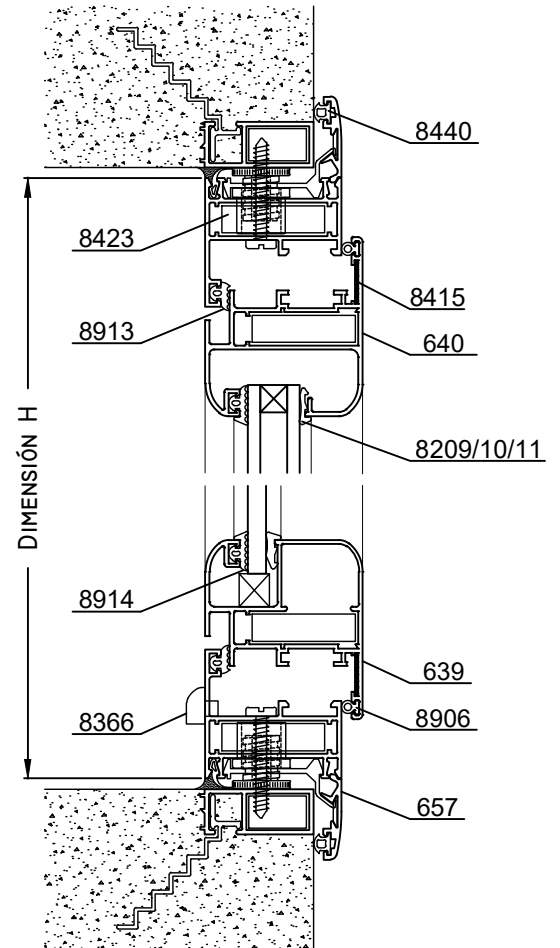

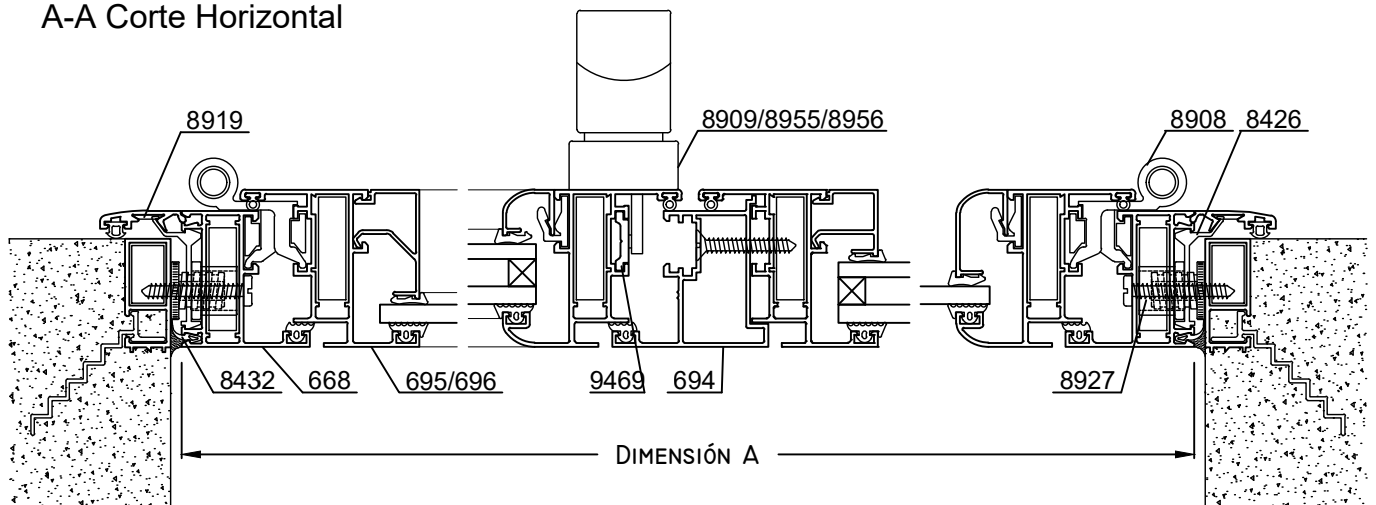

A-A Corte Horizontal



Escala 1:2.5

Tolerancia en Peso +/- 10% Tolerancia largo +10 mm -0 mm



09-06-23 DELTA.29

Dimensiones de Corte Ventana de Rebatir de 2 Hojas						
Función	Código	Peso kg/m	Forma	Cant.	Largo	Corte
Marco	668	0,66		2	A	45° 45°
				2	H	45° 45°
Hoja	695	0,86	-	4	A/2-23	45° 45°
	696	0,90		4	H-39	45° 45°
	639	0,99		4	A/2-23	45° 45°
	640	1,00		4	H-39	45° 45°
Inversor	694	0,80		1	H-94	90° 90°
Varilla	9469	0,16		2	S/F	90° 90°
Contravidrio	Contravidrios Curvos	-	-	4	A/2-107	45° 45°
				4	H-123	45° 45°
	Contravidrios Rectos	-	-	4	A/2-107	90° 90°
				4	H-157	90° 90°

- Medidas en milímetros
- S/F: Corte según Falleba
- Dimensiones de Corte de Premarco y Contramarco, en página 55









Detalle de Accesorios Ventana de Rebatir de 2 Hojas			
Código	Descripción	Forma	Cantidad
8423	Escuadra de Armado E-69		12 Unidades
8415	Escuadra Alineación de Hoja (a)	-	8 Unidades
-	Tornillo Parker 8 x 1½ T-15/F		s/m
8916	Clip Contravidrio T-96		s/m
8913	Burlete de Acristalamiento B-68		2A + 4H
8209	Cuña Chica		2A + 4H
8210	Cuña Mediana		
8211	Cuña Grande		
8906	Burlete AEL Europeo		2A + 3H
8914	Burlete de Hermeticidad B-67		2A + 3H
8909	Falleba Euro H-48 con Kit		1 Unidad
8955	Falleba Nova H-86 con Kit		
8909	Falleba Prima H-47 con Kit		
8912	Traba Varilla Simple H-43		2 Unidades
8908	Bisagra H-61 de 2 piezas con Kit		4 Unidades
8910	Pasador Chiudo H-49		2 Unidades
8451	Tapón Encuentro 2 Hojas T-98		2 Unidades
8366	Tapa Desague T-69		2 Unidades

- Detalle de Accesorios para Fijación, Premarco y Contramarco en página 55
- s/m : según medida
- a: Escuadra de alineación para Hoja 639 y 640

Dimensiones de Corte Ventana Oscilo-Batiente de 1 Hoja						
Función	Código	Peso Kg/m	Forma	Cant.	Largo	Corte
Marco	668	0,66		2	A	45° 45°
				2	H	45° 45°
Hoja	695	0,86	-	2	A-39	45° 45°
	696	0,90		2	H-39	45° 45°
	639	0,99		2	A-39	45° 45°
	640	1,00		2	H-39	45° 45°
Varilla	9469	0,16		2	Ver pág. 56	90° 90°
Contravidrio	Contravidrios Curvos	-	-	2	A-123	45° 45°
				2	H-123	45° 45°
	Contravidrios Rectos	-	-	2	A-123	90° 90°
				2	H-157	90° 90°

- Medidas en milímetros

- Dimensiones de Corte de Premarco y Contramarco, en página 55



Detalle de Accesorios Ventana Oscilo-Batiente de 1 Hoja			
Código	Descripción	Forma	Cantidad
8423	Escuadra de Armado E-69		8 Unidades
8415	Escuadra Alineación de Hoja (a)	-	8 Unidades
8916	Clip Contravidrio T-96		s/m
8913	Burlete de Acristalamiento B-68		2A + 2H
8209	Cuña Chica		2A + 2H
8210	Cuña Mediana		
8211	Cuña Grande		
8906	Burlete AEL Europeo		2A + 2H
8914	Burlete de Hermeticidad B-67		2A + 2H
9205	Falleba Euro o Prima para Oscilo-Batiente	-	1 Unidad
9206	Mecanismo OB para hoja de hasta 80 kg.	-	1 Unidad
9207	Brazo Tipo I (Ancho Hoja 410 a 570 m/m.)	-	1 Unidad
9208	Brazo Tipo II (Ancho Hoja 571 a 1700 m/m.)		
9209	Comp. Sup. (Ancho Hoja 1100 a 1700 m/m.)	-	Ver pág. 56
9210	Cierre Sup. (Alto Hoja superior a 1200 m/m. / Ancho Hoja superior a 1000 m/m.)	-	Ver pág. 56
8912	Traba Varilla Simple H-43		2 Unidades
8366	Tapa Desague T-69		2 Unidades

- Detalle de Accesorios para Fijación, Premarco y Contramarco en página 55

- s/m : según medida

- a: Escuadra de alineación para Hoja 639 y 640



Dimensiones de Corte Ventana Oscilo-Batiente de 2 Hojas						
Función	Código	Peso Kg/m	Forma	Cant.	Largo	Corte
Marco	668	0,66		2	A	45° 45°
				2	H	45° 45°
Hoja	695	0,86	-	4	A/2-23	45° 45°
	696	0,90		4	H-39	45° 45°
	639	0,99	-	4	A/2-23	45° 45°
	640	1,00		4	H-39	45° 45°
Inversor	694	0,80		1	H-94	90° 90°
Varilla	9469	0,16		2	Ver pág. 56	90° 90°
Contravidrio	Contravidrios Curvos	-	-	4	A/2-107	45° 45°
				4	H-123	45° 45°
	Contravidrios Rectos	-	-	4	A/2-107	90° 90°
				4	H-157	90° 90°

- Medidas en milímetros  
- Dimensiones de Corte de Premarco y Contramarco, en página 55

Detalle de Accesorios Ventana Oscilo-Batiente de 2 Hojas			
Código	Descripción	Forma	Cantidad
8423	Escuadra de Armado E-69		12 Unidades
-	Tornillo Parker 8 x 1½ T-15/F		s/m
8916	Clip Contravidrio T-96		s/m
8913	Burlete de Acristalamiento B-68		2A + 4H
8209	Cuña Chica		2A + 4H
8210	Cuña Mediana		
8211	Cuña Grande		
8906	Burlete AEL Europeo		2A + 3H
8914	Burlete de Hermeticidad B-67		2A + 3H
9205	Falleba Euro o Prima para Oscilo-Batiente	-	1 Unidad
9206	Mecanismo OB para hoja de hasta 80 kg.	-	1 Unidad
9207	Brazo Tipo I (Ancho Hoja 410 a 570 m/m.)	-	1 Unidad
9208	Brazo Tipo II (Ancho Hoja 571 a 1700 m/m.)		
9209	Comp. Sup. (Ancho Hoja 1100 a 1700 m/m.)	-	Ver pág. 56
9210	Cierre Sup. (Alto Hoja superior a 1200 m/m. / Ancho Hoja superior a 1000 m/m.)	-	Ver pág. 56
9212	Pasador para Hoja Pasiva H-83	-	2 Unidades
8908	Bisagra H-61 de 2 piezas con Kit		2 Unidades
9212	Pasador Hoja Pasiva H-83		2 Unidades
8451	Tapón Encuentro 2 Hojas T-98		2 Unidades
8366	Tapa Desague T-69		2 Unidades

- Detalle de Accesorios para Fijación, Premarco y Contramarco en página 55  
- s/m : según medida

Vista

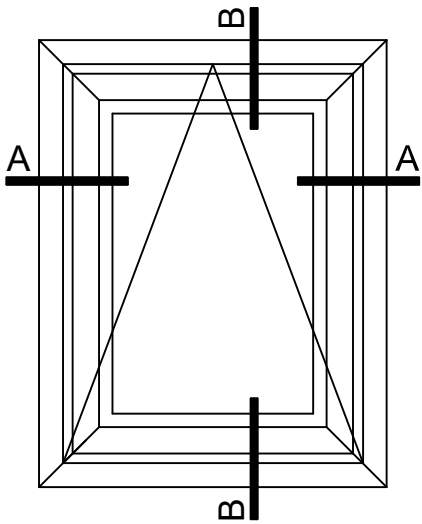

B-B Corte Vertical

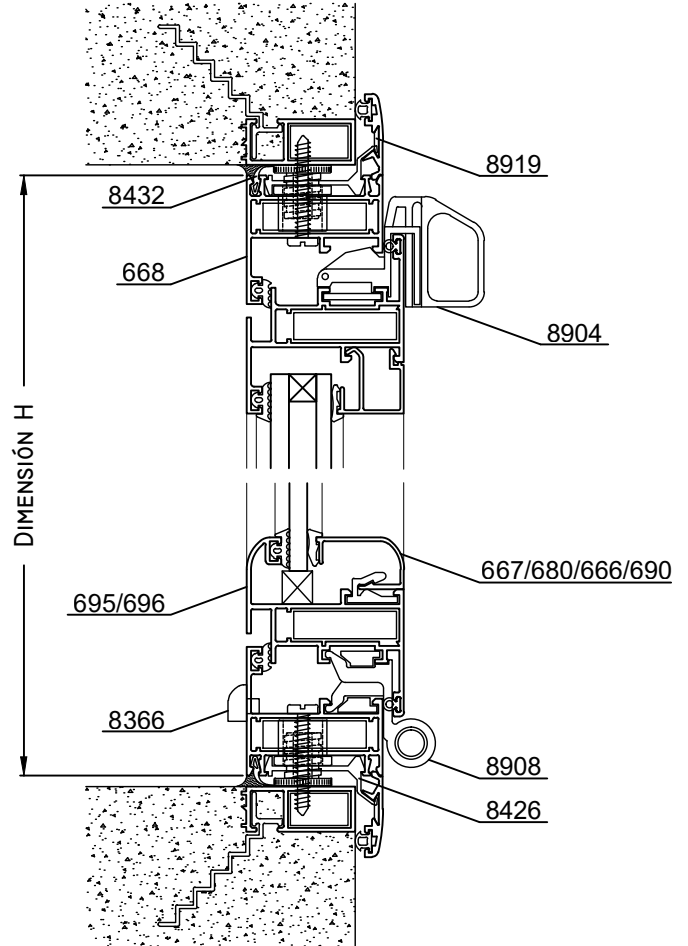

A-A Corte Horizontal

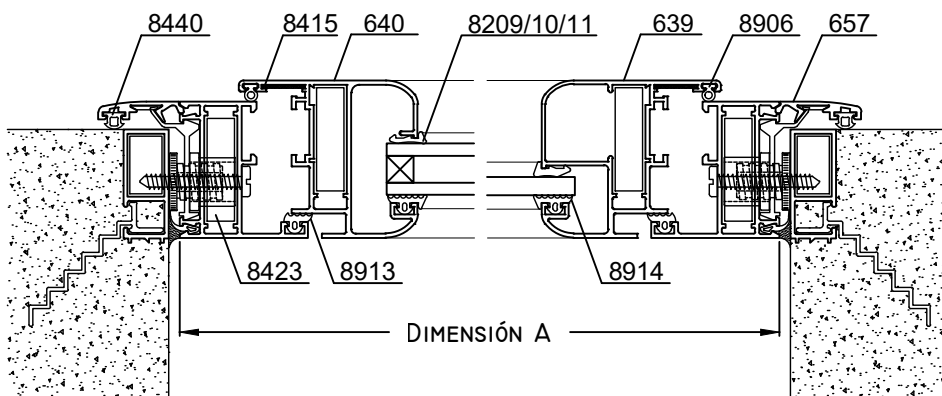

Escala 1:2.5











Tolerancia en Peso +/- 10% Tolerancia largo +10 mm -0 mm

09-06-23 DELTA.33

Dimensiones de Corte Ventana Banderola						
Función	Código	Peso Kg/m	Forma	Cant.	Largo	Corte
Marco	668	0,66		2	A	45° 45°
				2	H	45° 45°
Hoja	695	0,86	-	2	A-39	45° 45°
	696	0,90		2	H-39	45° 45°
	639	0,99	-	2	A-39	45° 45°
	640	1,00		2	H-39	45° 45°
Contravidrio	Contravidrios Curvos	-	-	2	A-123	45° 45°
				2	H-123	45° 45°
	Contravidrios Rectos	-	-	2	A-123	90° 90°
				2	H-157	90° 90°

- Medidas en milímetros

- Dimensiones de Corte de Premarco y Contramarco, en página 55

Detalle de Accesorios Ventana Banderola			
Código	Descripción	Forma	Cantidad
8423	Escuadra de Armado E-69		8 Unidades
8415	Escuadra Alineación de Hoja (a)	-	8 Unidades
8916	Clip Contravidrio T-96		s/m
8913	Burlete de Acristalamiento B-68		2A + 2H
8209	Cuña Chica		2A + 2H
8210	Cuña Mediana		
8211	Cuña Grande		
8906	Burlete AEL Europeo		2A + 2H
8914	Burlete de Hermeticidad B-67		2A + 2H
8904	Cierre Banderola H-52		1 Unidad
8443	Brazo Sostén H-53		1 Par
8908	Bisagra H-61 de 2 piezas con Kit		2 Unidades
8366	Tapa Desague T-69		2 Unidades

- Detalle de Accesorios para Fijación, Premarco y Contramarco en página 55

- s/m : según medida

(\*) En hojas de medidas superiores a 800mm de ancho se aconseja colocar 2 cierres

- a: Escuadra de alineación para Hoja 639 y 640

Vista

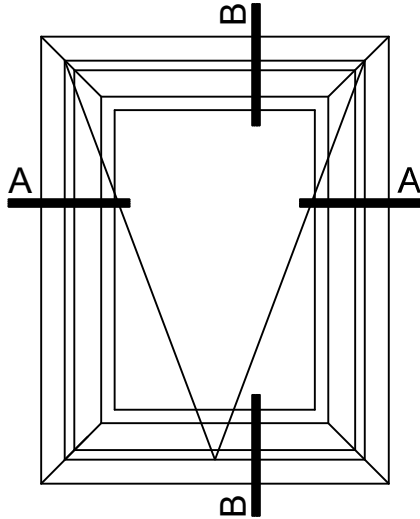

B-B Corte Vertical

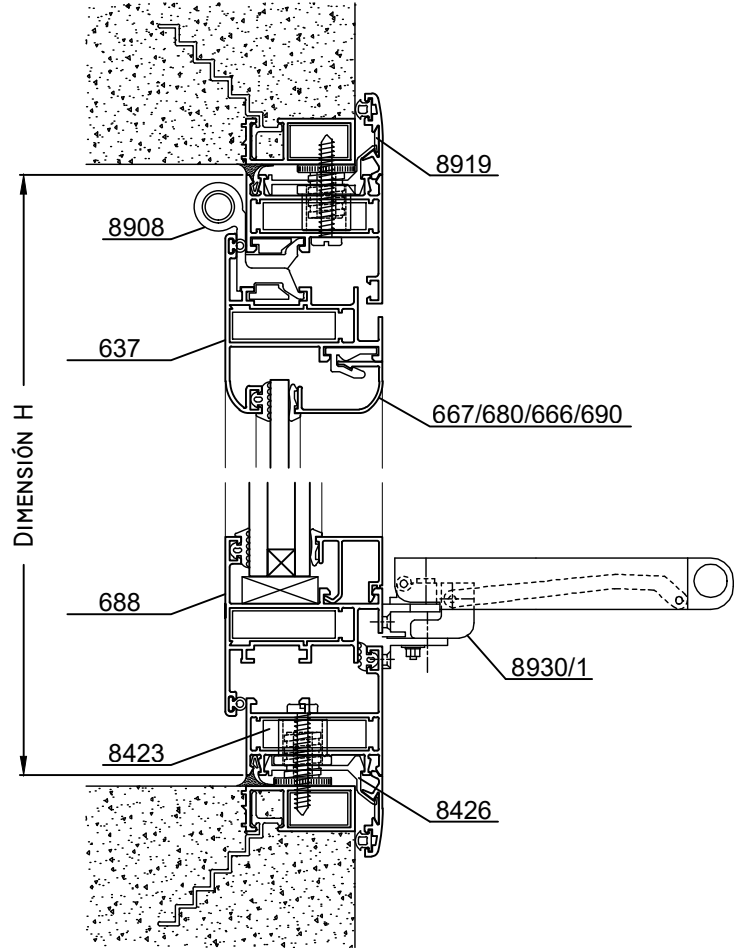

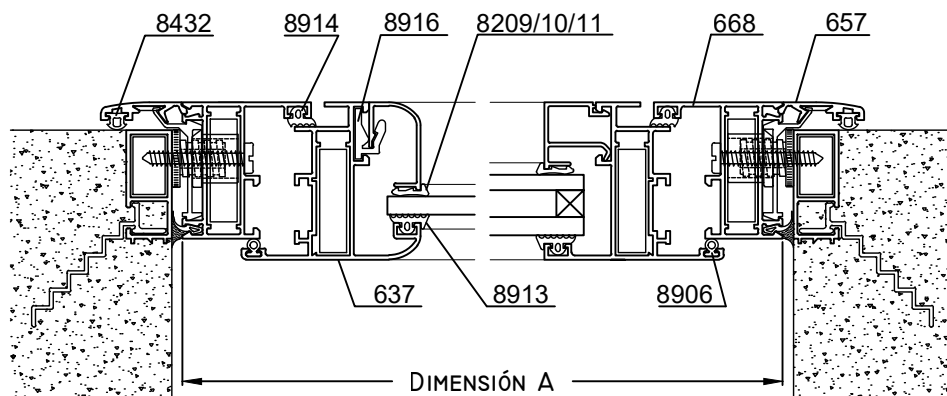

A-A Corte Horizontal



Escala 1:2.5









Tolerancia en Peso +/- 10% Tolerancia largo +10 mm -0 mm

09-06-23 DELTA.35

Dimensiones de Corte Ventana Ventiluz						
Función	Código	Peso Kg/m	Forma	Cant.	Largo	Corte
Marco	668	0,66		2	A	45° 45°
				2	H	45° 45°
Hoja	637	0,90		2	A-39	45° 45°
				2	H-39	45° 45°
	688	0,85		2	A-39	45° 45°
				2	H-39	45° 45°
Contravidrio	Contravidrios Curvos	-	-	2	A-123	45° 45°
				2	H-123	45° 45°
	Contravidrios Rectos	-	-	2	A-123	90° 90°
				2	H-157	90° 90°

- Medidas en milímetros

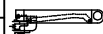
- Dimensiones de Corte de Premarco y Contramarco, en página 55

Detalle de Accesorios Ventana Ventiluz			
Código	Descripción	Forma	Cantidad
8423	Escuadra de Armado E-69		8 Unidades
8916	Clip Contravidrio T-96		s/m
8913	Burlete de Acristalamiento B-68		2A + 2H
8209	Cuña Chica		2A + 2H
8210	Cuña Mediana		
8211	Cuña Grande		
8906	Burlete AEL Europeo		2A + 2H
8914	Burlete de Hermeticidad B-67		2A + 2H
8930	Brazo Ombú Largo 224 mm. H-63		1 Unidad(*)
8931	Brazo Ombú Corto 160 mm. H-63		
8908	Bisagra H-61 de 2 piezas con Kit		2 Unidades
8366	Tapa Desague T-69		2 Unidades

- Detalle de Accesorios para Fijación, Premarco y Contramarco en página 55

- s/m : según medida

(\*) En hojas de medidas superiores a 800mm de ancho se aconseja colocar 2 brazos de empuje

Vista

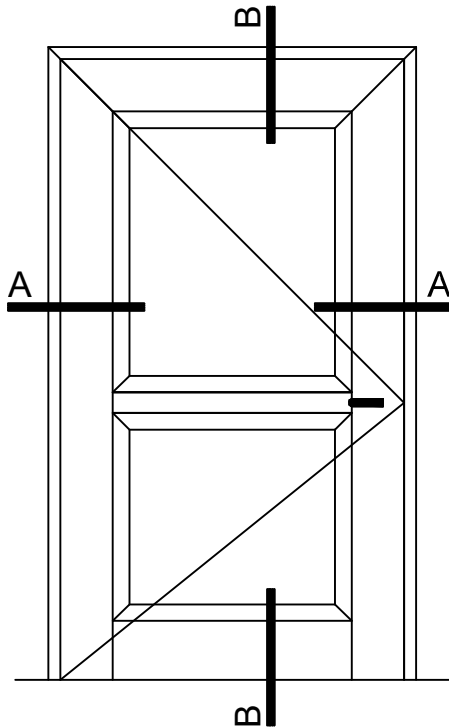

B-B Corte Vertical

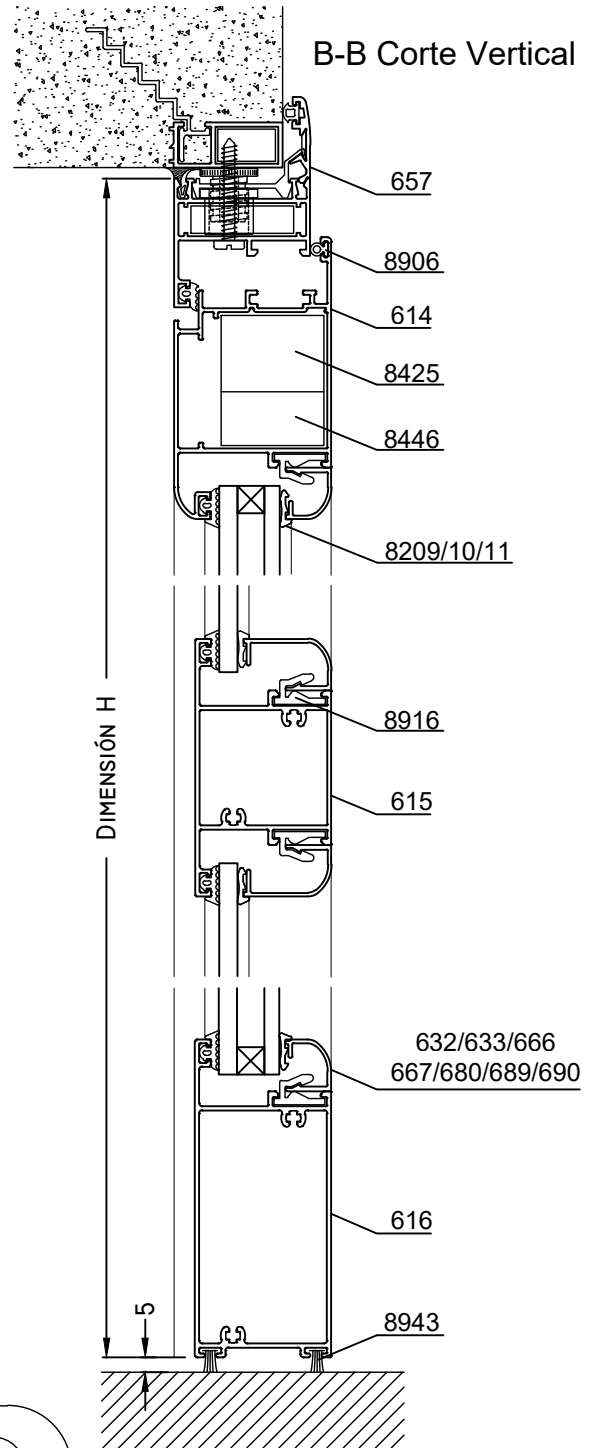

A-A Corte Horizontal

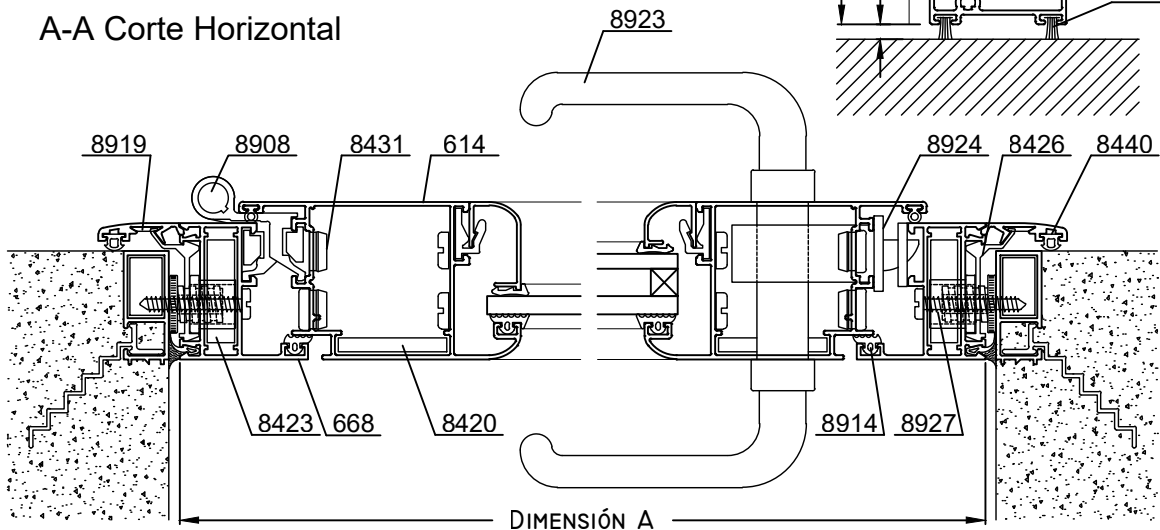

Escala 1:2.5

Tolerancia en Peso +/- 10% Tolerancia largo +10 mm -0 mm

09-06-23 DELTA.37

Dimensiones de Corte Puerta de Rebatir de 1 Hoja				Sin Travesaño			Con 1 Travesaño		
Función	Código	Peso Kg/m	Forma	Cant.	Largo	Corte	Cant.	Largo	Corte
Marco	668	0,66		1	A	45° 45°	1	A	45° 45°
				2	H	45° 90°	2	H	45° 90°
Parante	614	1,15		1	A-39	45° 45°	1	A-39	45° 45°
				2	H-25	45° 90°	2	H-24	45° 90°
Zócalo	616	1,29		1	A-192	90° 90°	1	A-192	90° 90°
Travesaño	615	1,09		-	-	-	1	A-192	90° 90°
Contravidrio Interior	Contravidrios Curvos	-	-	2	A-191	45° 45°	4	A-191	45° 45°
				2	H-223	45° 45°	4	H/2-142	45° 45°
	Contravidrios Rectos	-	-	2	A-191	90° 90°	4	A-191	90° 90°
				2	H-257	90° 90°	4	H/2-176	90° 90°

- Medidas en milímetros

- Dimensiones de Corte de Premarco y Contramarco, en página 55

Detalle de Accesorios Puerta de Rebatir de 1 Hoja			
Código	Descripción	Forma	Cantidad
8423	Escuadra de Armado E-69		2 Unidades
8425	Escuadra Parante E-70		2 Unidades
8446	Escuadra Suplementaria 40.5 mm. E-67		2 Unidades
8419	Tornillo Parker 12 x 1½ T-20		4 Unidades + 4U. x trav.
8431	Tapa Tornillo T-100		4 Unidades + 4U. x trav.
8916	Clip Contravidrio T-96		s/m
8913	Burlete de Acristalamiento B-68		2A + 2H + 2A x trav.
8209	Cuña Chica		2A + 2H + 2A x trav.
8210	Cuña Mediana		
8211	Cuña Grande		
8906	Burlete AEL Europeo		1A + 2H
8914	Burlete de Hermeticidad B-67		1A + 2H
8923	Manija Prima H-93		1 Unidad
8924	Cerradura H-51 (Kallay 5006)		1 Unidad
8920	Bisagra H-62 de 3 piezas con Kit		3 Unidades
8943	Felpa de 7x6 con Fin Seal		2A
8420	Porta Felpa T-99		2 Unidades

- Detalle de Accesorios para Fijación, Premarco y Contramarco en página 55

- s/m : según medida

Vista

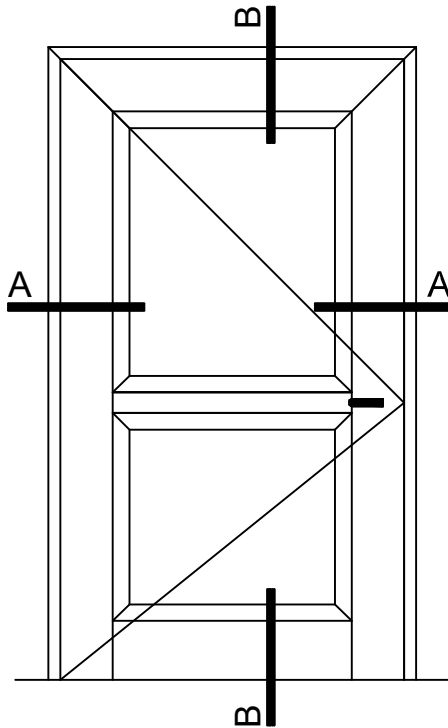

B-B Corte Vertical

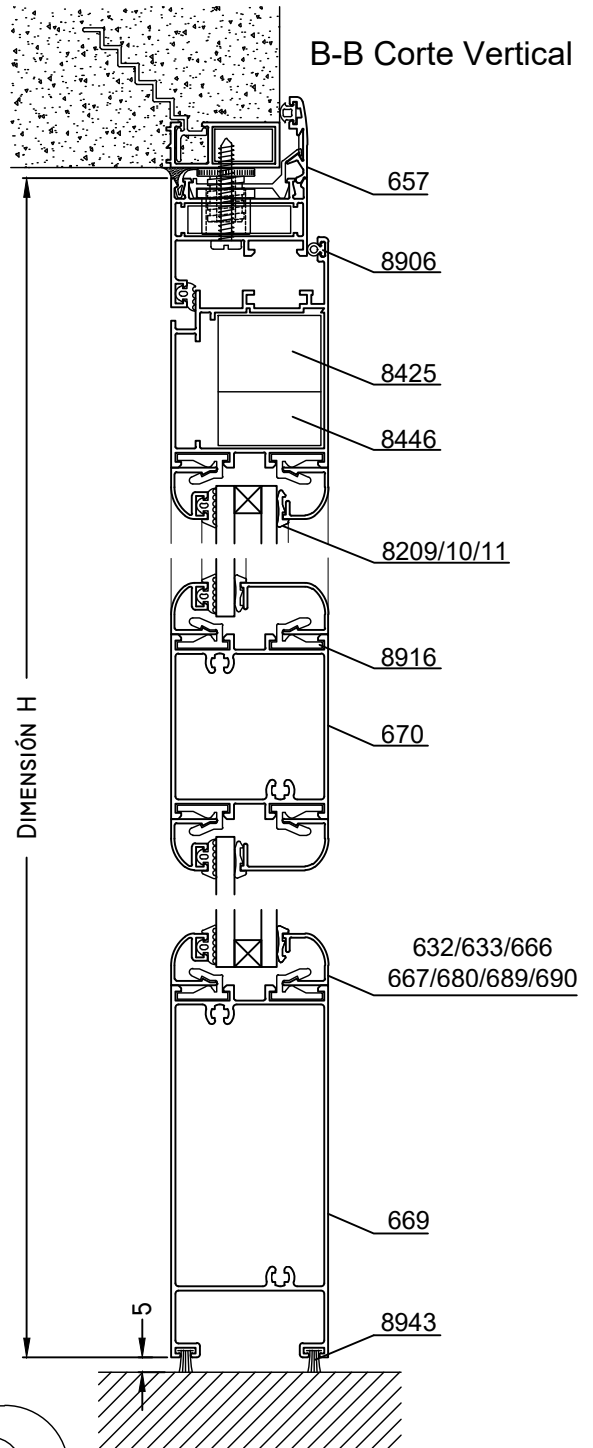

A-A Corte Horizontal

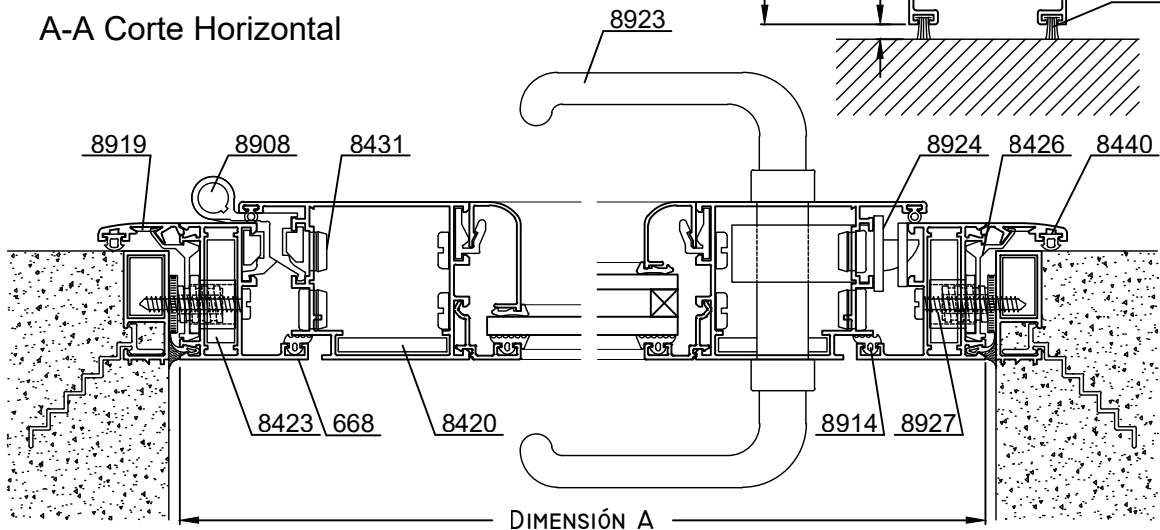

Escala 1:2.5

Tolerancia en Peso +/- 10% Tolerancia largo +10 mm -0 mm

09-06-23 DELTA.39



Dimensiones de Corte Puerta de Rebatir de 1 Hoja				Sin Travesaño			Con 1 Travesaño		
Función	Código	Peso Kg/m	Forma	Cant.	Largo	Corte	Cant.	Largo	Corte
Marco	668	0,66		1	A	45° 45°	1	A	45° 45°
				2	H	45° 90°	2	H	45° 90°
Parante	671	0,94		1	A-39	45° 45°	1	A-39	45° 45°
				2	H-25	45° 90°	2	H-24	45° 90°
Zócalo	669	1,63		1	A-192	90° 90°	1	A-192	90° 90°
Travesaño	670	1,01		-	-	-	1	A-192	90° 90°
Contravidrio Interior	Contravidrios Curvos	-	-	2	A-191	45° 45°	4	A-191	45° 45°
				2	H-223	45° 45°	4	H/2-142	45° 45°
	Contravidrios Rectos	-	-	2	A-191	90° 90°	4	A-191	90° 90°
				2	H-257	90° 90°	4	H/2-176	90° 90°
Contravidrio Exterior	672	0,18		2	A-191	45° 45°	4	A-191	45° 45°
				2	H-223	45° 45°	4	H/2-142	45° 45°
	644	0,18		2	A-191	90° 90°	4	A-191	90° 90°
				2	H-257	90° 90°	4	H/2-176	90° 90°

- Medidas en milímetros

- Dimensiones de Corte de Premarco y Contramarco, en página 55

Detalle de Accesorios Puerta de Rebatir de 1 Hoja			
Código	Descripción	Forma	Cantidad
8423	Escuadra de Armado E-69		2 Unidades
8425	Escuadra Parante E-70		2 Unidades
8446	Escuadra Suplementaria 40.5 mm. E-67		2 Unidades
8419	Tornillo Parker 12 x 1½ T-20		4 Unidades + 4U. x trav.
8431	Tapa Tornillo T-100		4 Unidades + 4U. x trav.
8916	Clip Contravidrio T-96		s/m
8913	Burlete de Acristalamiento B-68		2A + 2H + 2A x trav.
8209	Cuña Chica		2A + 2H + 2A x trav.
8210	Cuña Mediana		
8211	Cuña Grande		
8906	Burlete AEL Europeo		1A + 2H
8914	Burlete de Hermeticidad B-67		1A + 2H
8923	Manija Prima H-93		1 Unidad
8924	Cerradura H-51 (Kallay 5006)		1 Unidad
8920	Bisagra H-62 de 3 piezas con Kit		3 Unidades
8943	Felpa de 7x6 con Fin Seal		2A
8420	Porta Felpa T-99		2 Unidades

- Detalle de Accesorios para Fijación, Premarco y Contramarco en página 55

- s/m : según medida

Tolerancia en Peso +/- 10% Tolerancia largo +10 mm -0 mm

09-06-23 DELTA.40

Vista

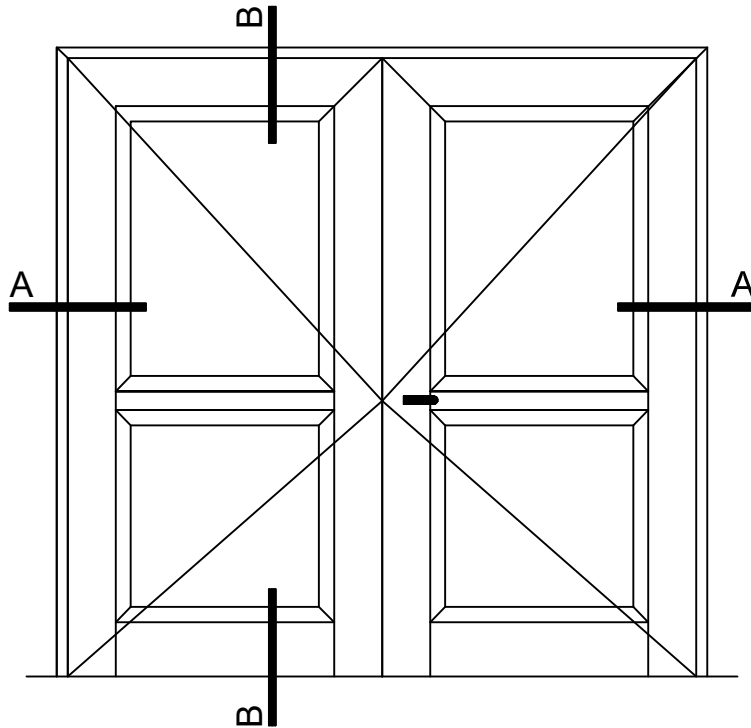

B-B Corte Vertical

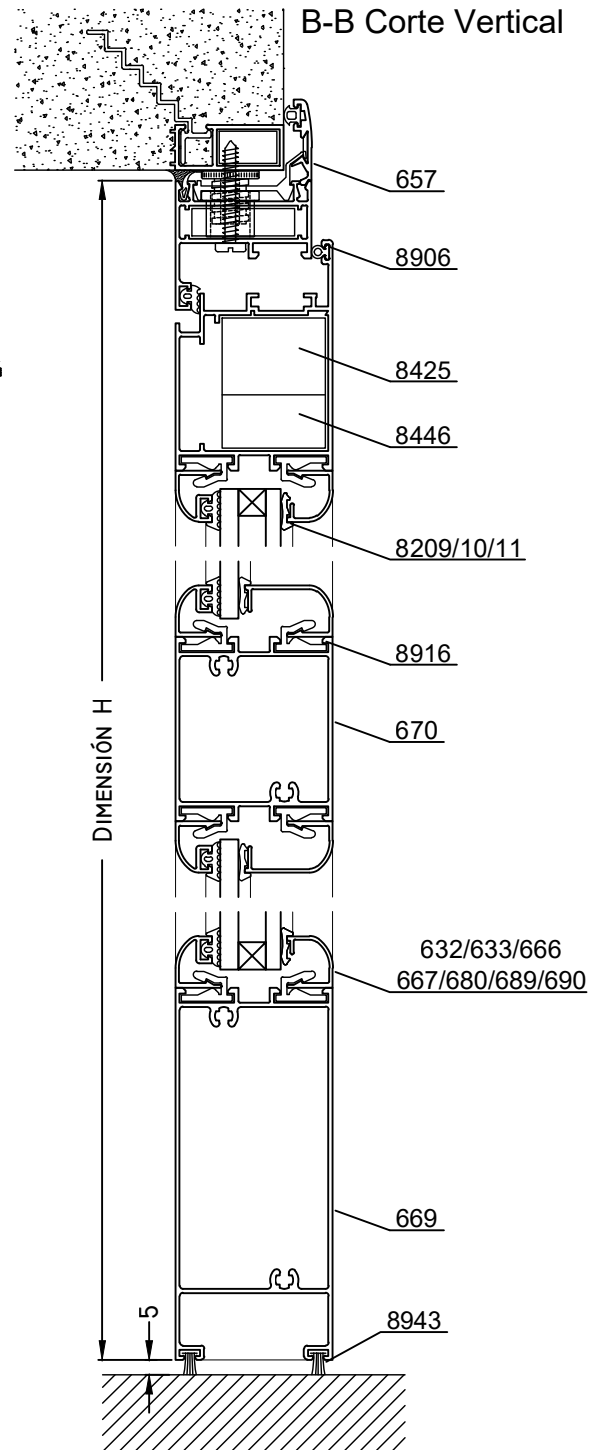

A-A Corte Horizontal

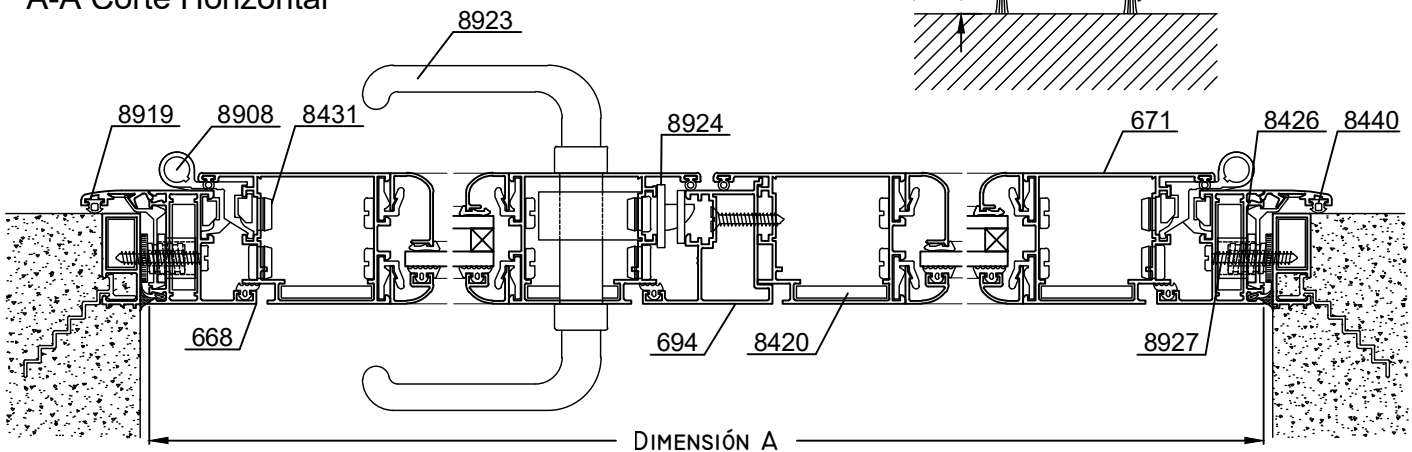

Escala 1:2.5

Tolerancia en Peso +/- 10% Tolerancia largo +10 mm -0 mm

09-06-23 DELTA.41

Dimensiones de Corte Puerta de Rebatir de 2 Hojas				Sin Travesaño			Con 1 Travesaño		
Función	Código	Peso Kg/m	Forma	Cant.	Largo	Corte	Cant.	Largo	Corte
Marco	668	0,66		1	A	45° 45°	1	A	45° 45°
				2	H	45° 90°	2	H	45° 90°
Parante	671	0,94		2	A/2-23	45° 45°	2	A/2-23	45° 45°
				4	H-25	45° 90°	4	H-25	45° 90°
Zócalo	669	1,63		2	A/2-175	90° 90°	2	A/2-175	90° 90°
Travesaño	670	1,01		-	-	-	1	A/2-175	90° 90°
Inversor	694	0,80		1	H-53	90° 90°	1	H-53	90° 90°
Contravidrio Interior	Contravidrios Curvos	-	-	4	A/2-175	45° 45°	8	A/2-175	45° 45°
				4	H-223	45° 45°	8	H-223	45° 45°
	Contravidrios Rectos	-	-	4	A/2-175	90° 90°	8	A/2-175	90° 90°
				4	H-257	90° 90°	8	H-257	90° 90°
Contravidrio Exterior	672	0,18		4	A/2-175	45° 45°	8	A/2-175	45° 45°
				4	H-223	45° 45°	8	H-223	45° 45°

Detalle de Accesorios Puerta de Rebatir de 2 Hojas			
Código	Descripción	Forma	Cantidad
8423	Escuadra de Armado E-69		2 Unidades
8425	Escuadra Parante E-70		4 Unidades
8446	Escuadra Suplementaria 40.5 mm. E-67		4 Unidades
8419	Tornillo Parker 12 x 1½ T-20		8 Unidades + 8U. x trav.
8431	Tapa Tornillo T-100		8 Unidades + 8U. x trav.
8916	Clip Contravidrio T-96		s/m
8913	Burlete de Acristalamiento B-68		2A + 2H + 2A x trav.
8209	Cuña Chica		2A + 2H + 2A x trav.
8210	Cuña Mediana		
8211	Cuña Grande		
8906	Burlete AEL Europeo		1A + 4H
8914	Burlete de Hermeticidad B-67		1A + 3H
8923	Manija Prima H-93		1 Unidad
8924	Cerradura H-51 (Kallay 5006)		1 Unidad
8920	Bisagra H-62 de 3 piezas con Kit		6 Unidades
8943	Felpa de 7x6 con Fin Seal		2A
8420	Porta Felpa T-99		4 Unidades
9124	Pasador H-42		2 Unidades
8451	Tapón Encuentro 2 Hojas T-98		2 Unidades

- Medidas en milímetros  
 - Dimensiones de Corte de Premarco y Contramarco, en página 55

- Detalle de Accesorios para Fijación, Premarco y Contramarco en página 55  
 - s/m : según medida

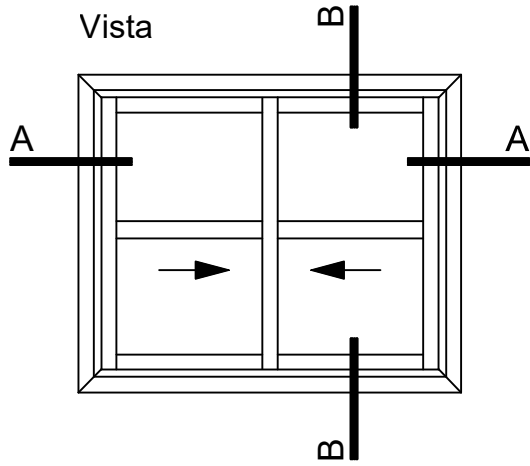

- Opción para Vidrio Simple o Laminado

B-B Corte Vertical

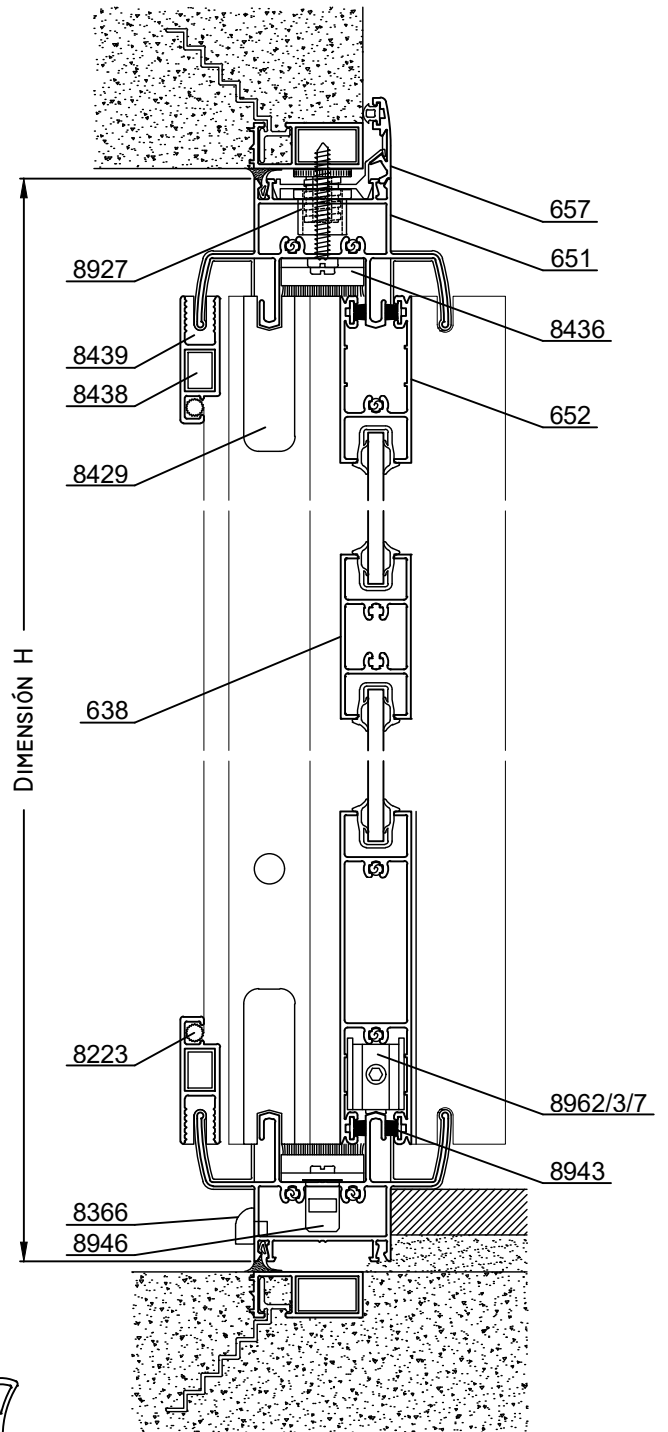

A-A Corte Horizontal

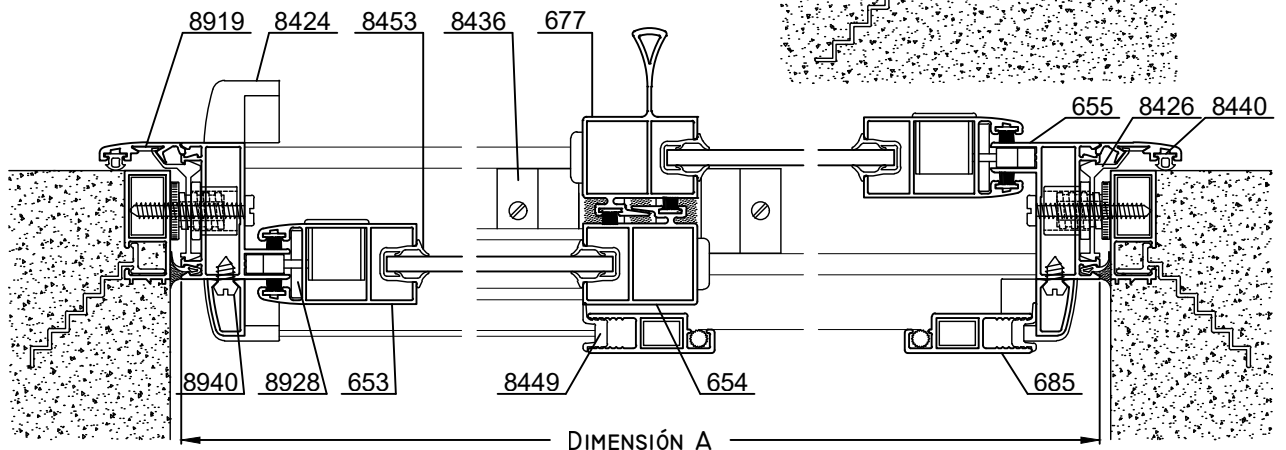

Escala 1:2.5

Tolerancia en Peso +/- 10% Tolerancia largo +10 mm -0 mm

09-06-23 DELTA.43

- Opción para Vidrio Simple o Laminado

Dimensiones de Corte Ventana y Puerta Corrediza 2 Hojas				Ventana Corrediza			Puerta Corrediza		
Función	Código	Peso Kg/m	Forma	Cant.	Largo	Corte	Cant.	Largo	Corte
Umbral y Dintel	651	1,21		2	A-42	90° 90°	2	A-42	90° 90°
Jamba	655	0,59		2	H	90° 90°	2	H	90° 90°
Parante Lateral	653	0,64		2	H-79	90° 90°	2	H-79	90° 90°
Parante Central	654	0,58		2	H-79	90° 90°	1	H-79	90° 90°
Par. Central con Tirador	677	0,79		-	-	-	1	H-79	90° 90°
Zócalo	652	0,64		4	A/2-24	90° 90°	2	A/2-24	90° 90°
Zócalo Alto	660	1,26		-	-	-	2	A/2-24	90° 90°
Travesaño	638	0,70		-	A/2-67	90° 90°	-	A/2-67	90° 90°
Mosquitero	685	0,38		2	A/2-7	45° 45°	2	A/2-7	45° 45°
				2	H-88	45° 45°	2	H+88	45° 45°
Tope Mosquitero	708	0,19		2	H-100	90° 90°	2	H-100	90° 90°

- Medidas en milímetros

- Dimensiones de Corte de Premarco y Contramarco, en página 55

Detalle de Accesorios Ventana y Puerta Corrediza 2 Hojas			Ventana	Puerta
Código	Descripción	Forma	Cantidad	Cantidad
8362	Tornillo Parker 10 x 1½ T-1		16 Unidades	20 Unidades
8453	Burlete en "U" para Vidrio B-60		2A + 4H	
8424	Tope Canal de Condensación T-91		4 Unidades	
8943	Felpa de 7x6 con Fin Seal		4A + 6H	
8181	Cierre Lateral Milano H-56 sin Kit		2 Unidades	
8168	Kit Delta p/cierre Lateral Milano			
8428	Tope Parante Lateral T-89		4 Unidades	
8429	Tope Parante Central T-90		4 Unidades	
8427	Rueda Ibiza Doble Regulable R-40 - 40 kg.		4 Unidades	
8430	Rueda Monza R-39			
8435	Rueda Imola R-39			
8437	Rueda Imola Simple R-41			
8441	Rueda Regulable R-42 - 40 kg.			
8445	Rueda Ibiza Doble R-42			
8454	Rueda Ibiza Simple R-40 - 20 kg.			
8436	Cruce Central de Hoja T-93		2 Unidades	
8946	Boca Desagüe T-94		s/m	
8366	Tapa Desagüe T-69		2 Unidades	
8434	Junta de Estanqueidad T-92		4 Unidades	

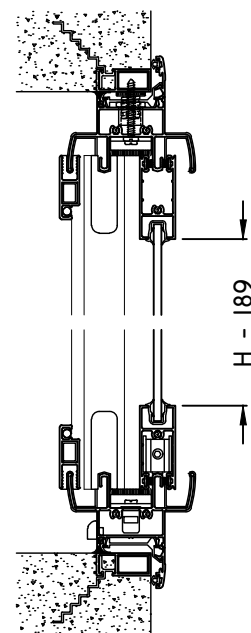

- Detalle de Accesorios para Fijación, Premarco, Contramarco y Mosquitero en página 55  
- s/m : según medida

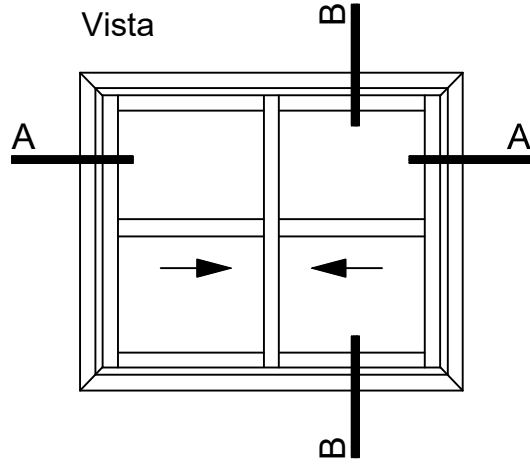

- Opción para Doble Vidriado Hermético (D.V.H)

B-B Corte Vertical

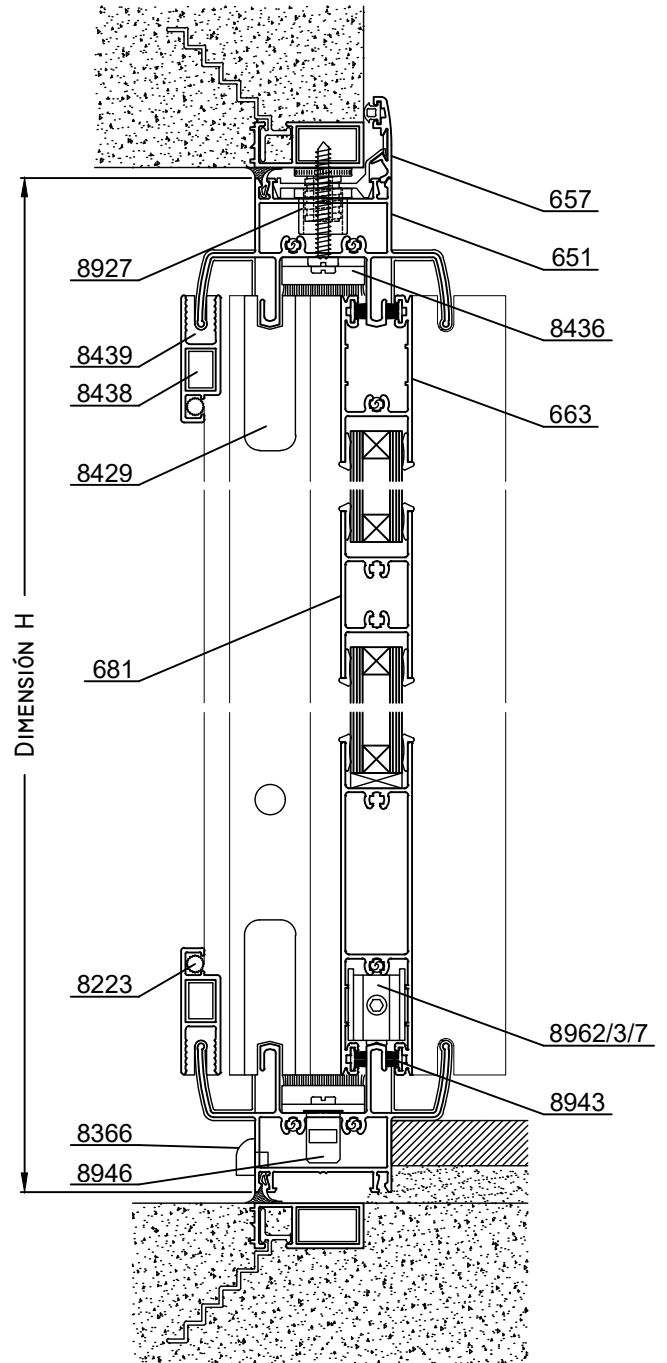

A-A Corte Horizontal

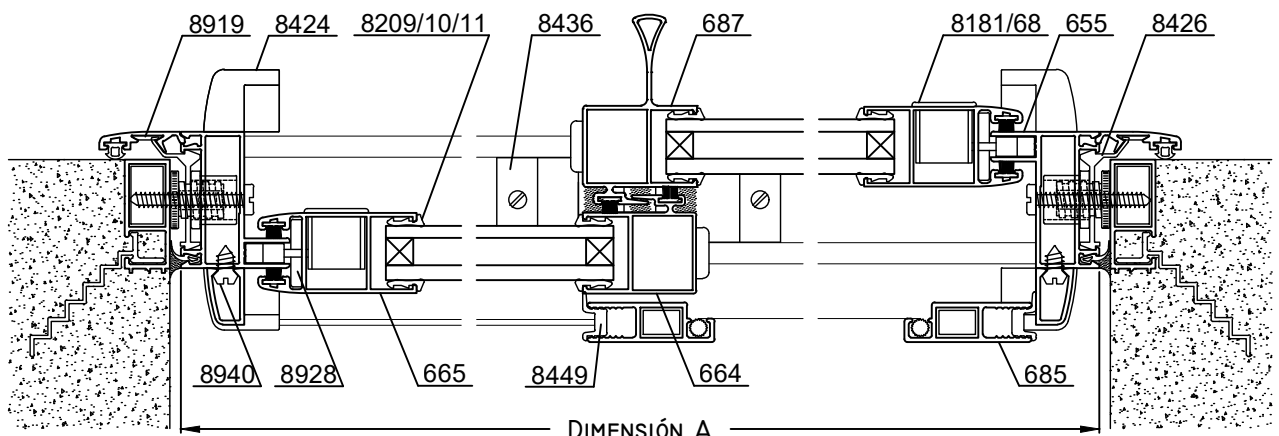

Escala 1:2.5

Tolerancia en Peso +/- 10% Tolerancia largo +10 mm -0 mm

09-06-23 DELTA.45

- Opción para Doble Vidriado Hermético (D.V.H)

Dimensiones de Corte Ventana y Puerta Corrediza 2 Hojas				Ventana Corrediza			Puerta Corrediza		
Función	Código	Peso (g/m)	Forma	Cant.	Largo	Corte	Cant.	Largo	Corte
Umbral y Dintel	651	1,21		2	A-42	90° 90°	2	A-42	90° 90°
Jamba	655	0,59		2	H	90° 90°	2	H	90° 90°
Parante Lateral	665	0,59		2	H-79	90° 90°	2	H-79	90° 90°
Parante Central	664	0,56		2	H-79	90° 90°	1	H-79	90° 90°
Par. Central con Tirador	687	0,76		-	-	-	1	H-79	90° 90°
Zócalo	663	0,68		4	A/2-24	90° 90°	2	A/2-24	90° 90°
Zócalo Alto	686	1,23		-	-	-	2	A/2-24	90° 90°
Travesaño	681	0,70		-	A/2-67	90° 90°	-	A/2-67	90° 90°
Mosquitero	685	0,38		2	A/2-7	45° 45°	2	A/2-7	45° 45°
				2	H-88	45° 45°	2	H+88	45° 45°
Tope Mosquitero	708	0,19		2	-	90° 90°	1	-	90° 90°

- Medidas en milímetros

- Dimensiones de Corte de Premarco y Contramarco, en página 55

Detalle de Accesorios Ventana y Puerta Corrediza 2 Hojas			Ventana	Puerta
Código	Descripción	Forma	Cantidad	Cantidad
8362	Tornillo Parker 10 x 1½ T-1		16 Unidades	20 Unidades
8209	Cuña Chica		4A + 8H	
8210	Cuña Mediana			
8211	Cuña Grande			
8424	Tope Canal de Condensación T-91		4 Unidades	
8943	Felpa de 7x6 con Fin Seal		4A + 6H	
8181	Cierre Lateral Milano H-56 sin Kit		2 Unidades	
8168	Kit Delta p/cierre Lateral Milano			
8428	Tope Parante Lateral T-89		4 Unidades	
8429	Tope Parante Central T-90		4 Unidades	
8427	Rueda Ibiza Doble Regulable R-40 - 40 kg.		4 Unidades	
8430	Rueda Monza R-39			
8435	Rueda Imola R-39			
8437	Rueda Imola Simple R-41			
8441	Rueda Regulable R-42 - 40 kg.			
8445	Rueda Ibiza Doble R-42			
8454	Rueda Ibiza Simple R-40 - 20 kg.			
8436	Cruce Central de Hoja T-93		2 Unidades	
8946	Boca Desagüe T-94		s/m	
8366	Tapa Desagüe T-69		2 Unidades	
8434	Junta de Estanqueidad T-92		4 Unidades	

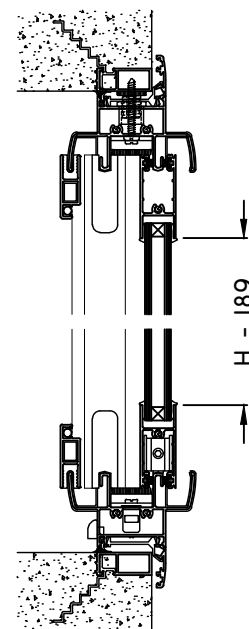

- Detalle de Accesorios para Fijación, Premarco, Contramarco y Mosquitero en página 55  
- s/m : según medida

Tolerancia en Peso +/- 10% Tolerancia largo +10 mm -0 mm

09-06-23 DELTA.46

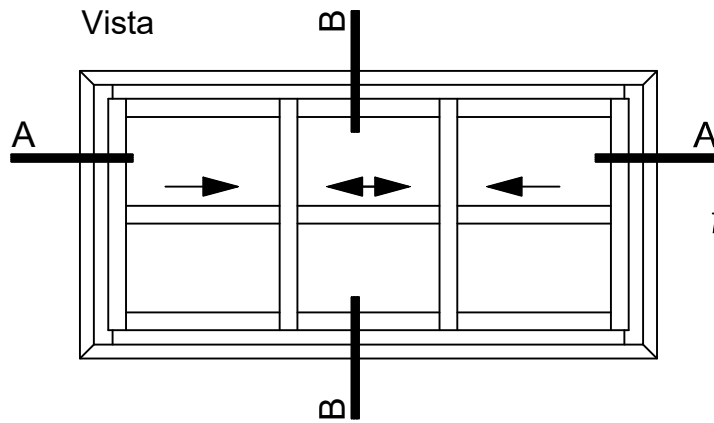

- Opción para Vidrio Simple o Laminado

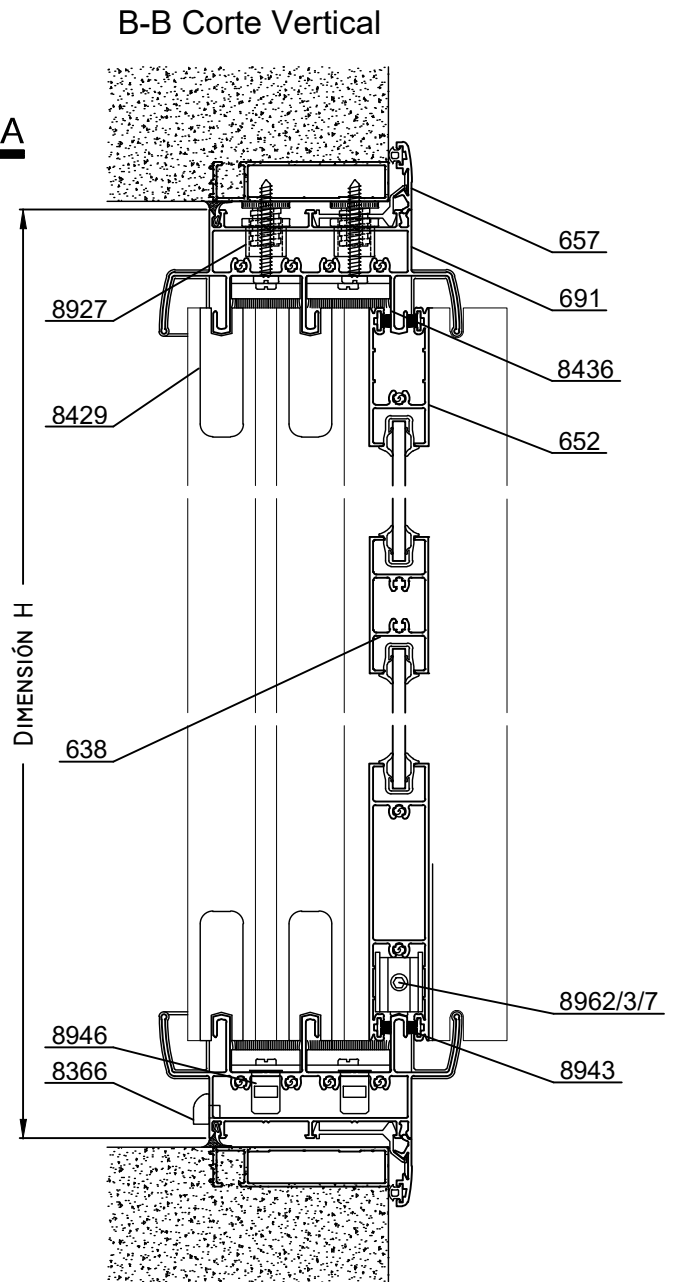

A-A Corte Horizontal

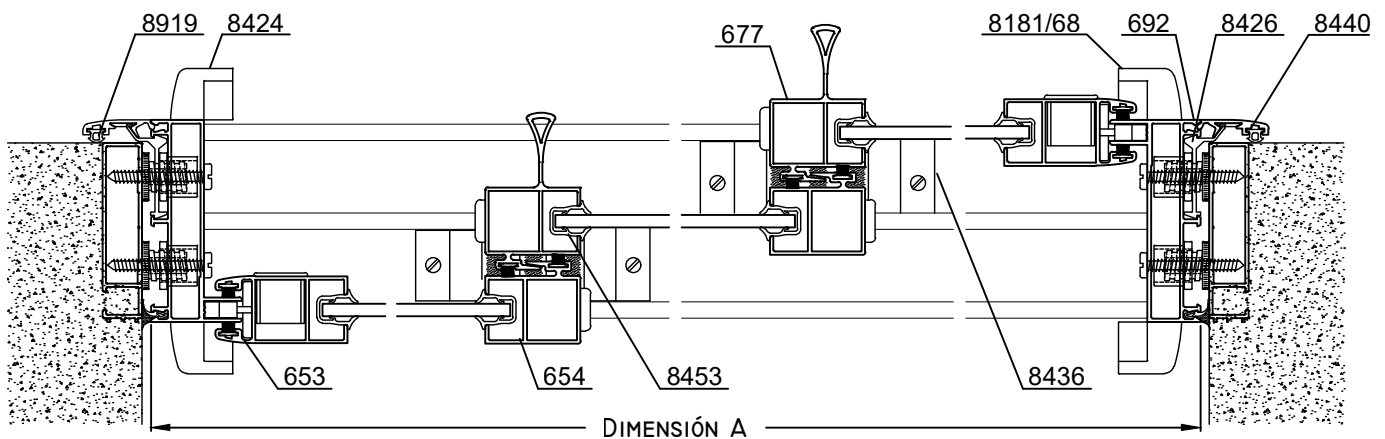







Escala 1:3

Tolerancia en Peso +/- 10% Tolerancia largo +10 mm -0 mm

09-06-23 DELTA.47















- Opción para Vidrio Simple o Laminado

Dimensiones de Corte Ventana y Puerta Corrediza 3 Hojas				Ventana Corrediza			Puerta Corrediza		
Función	Código	Peso kg/m	Forma	Cant.	Largo	Corte	Cant.	Largo	Corte
Umbral y Dintel	691	1,83		2	A-42	90° 90°	2	A-42	90° 90°
Jamba	655	0,59		2	H	90° 90°	2	H	90° 90°
Parante Lateral	653	0,64		2	H-79	90° 90°	2	H-79	90° 90°
Parante Central	654	0,58		4	H-79	90° 90°	2	H-79	90° 90°
Par. Central con Tirador	677	0,79		-	-	-	2	H-79	90° 90°
Zócalo	652	0,64		4 2	A/3-7 A/3+1	90° 90°	2 1	A/3-7 A/3+1	90° 90°
Zócalo Alto	660	1,26		-	-	-	2 1	A/3-7 A/3+1	90° 90°
Travesaño	638	0,70		-	A/3-50 A/3+44	90° 90°	-	A/3-50 A/3+44	90° 90°

- Medidas en milímetros

- Dimensiones de Corte de Premarco y Contramarco, en página 55

Detalle de Accesorios Ventana y Puerta Corrediza 3 Hojas			Ventana	Puerta
Código	Descripción	Forma	Cantidad	Cantidad
8362	Tornillo Parker 10 x 1½ T-1		28 Unidades	34 Unidades
8453	Burlete en "U" para Vidrio B-60		2A + 6H	
8424	Tope Canal de Condensación T-91		4 Unidades	
8943	Felpa de 7x6 con Fin Seal		4A + 8H	
8181	Cierre Lateral Milano H-56 sin Kit		2 Unidades	
8168	Kit Delta p/cierre Lateral Milano			
8428	Tope Parante Lateral T-89		4 Unidades	
8429	Tope Parante Central T-90		8 Unidades	
8427	Rueda Ibiza Doble Regulable R-40 - 40 kg.		6 Unidades	
8430	Rueda Monza R-39			
8435	Rueda Imola R-39			
8437	Rueda Imola Simple R-41			
8441	Rueda Regulable R-42 - 40 kg.			
8445	Rueda Ibiza Doble R-42			
8454	Rueda Ibiza Simple R-40 - 20 kg.			
8436	Cruce Central de Hoja T-93		4 Unidades	
8946	Boca Desagüe T-94		s/m	
8366	Tapa Desagüe T-69		2 Unidades	
8416	Junta de Estanqueidad T-101		4 Unidades	

- Detalle de Accesorios para Fijación y Contramarco en página 55

- s/m : según medida

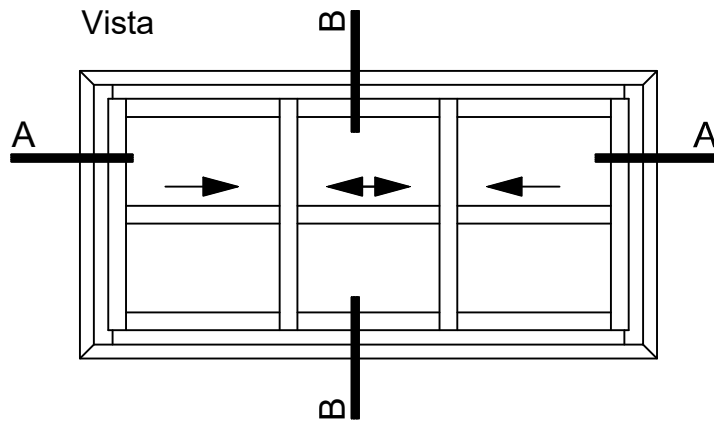

- Opción para Doble Vidriado Hermético (D.V.H)

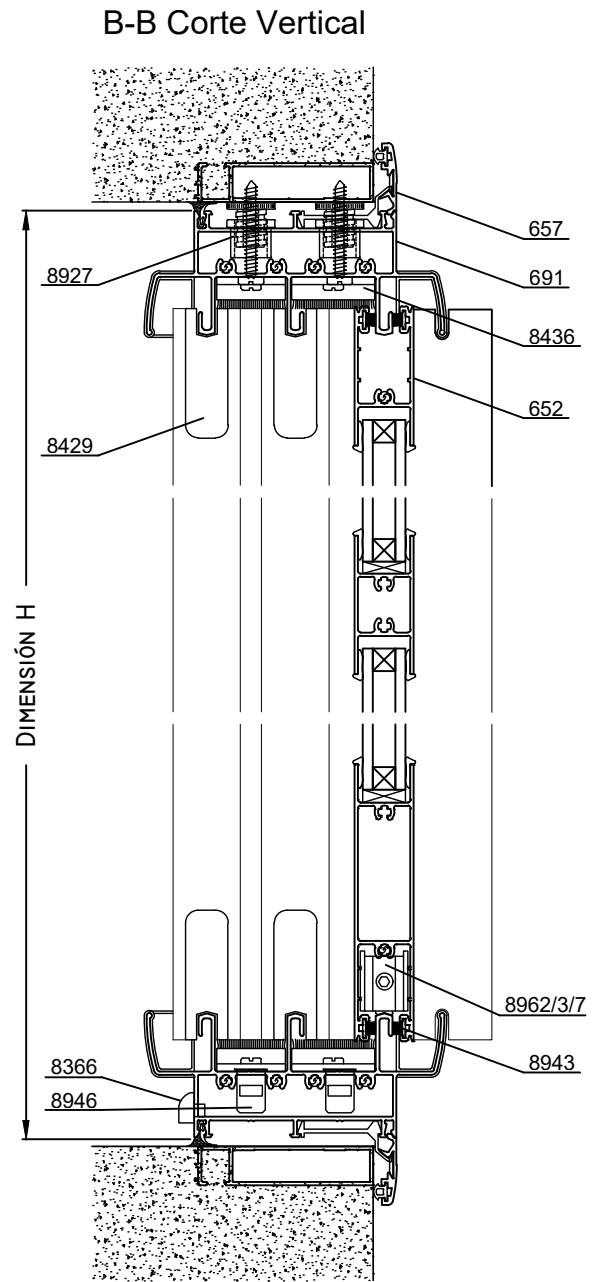

A-A Corte Horizontal

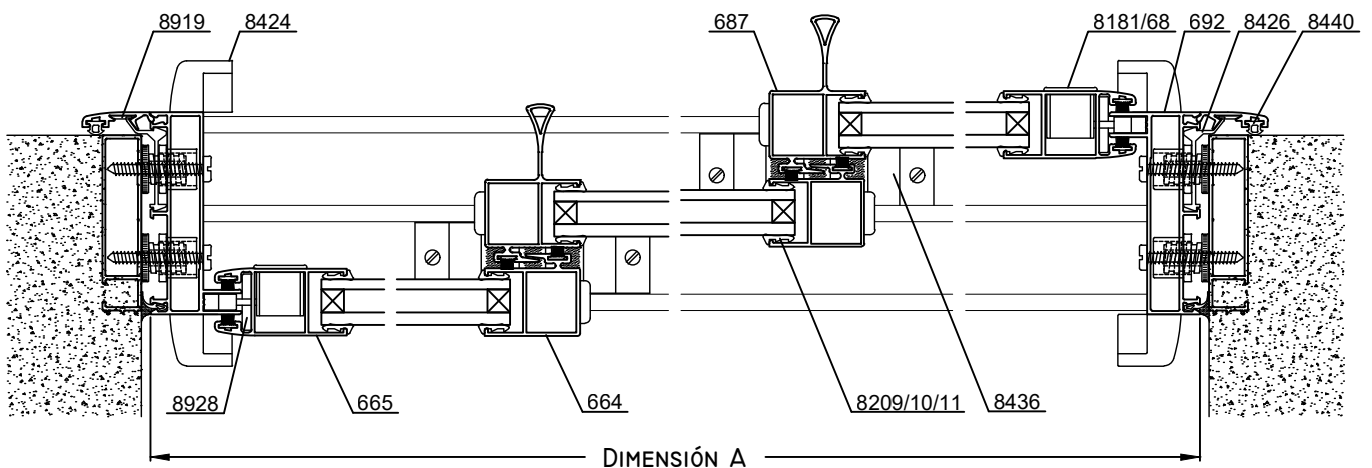





Escala 1:2.5

Tolerancia en Peso +/- 10% Tolerancia largo +10 mm -0 mm











09-06-23 DELTA.49

- Opción para Doble Vidriado Hermético (D.V.H)

Dimensiones de Corte Ventana y Puerta Corrediza 3 Hojas				Ventana Corrediza			Puerta Corrediza		
Función	Código	Peso kg/m	Forma	Cant.	Largo	Corte	Cant.	Largo	Corte
Umbral y Dintel	691	1,83		2	A-42	90° 90°	2	A-42	90° 90°
Jamba	655	0,59		2	H	90° 90°	2	H	90° 90°
Parante Lateral	665	0,59		2	H-79	90° 90°	2	H-79	90° 90°
Parante Central	664	0,56		4	H-79	90° 90°	2	H-79	90° 90°
Par. Central con Tirador	687	0,76		-	-	-	2	H-79	90° 90°
Zócalo	663	0,68		4 2	A/3-7 A/3+1	90° 90°	2 1	A/3-7 A/3+1	90° 90°
Zócalo Alto	686	1,23		-	-	-	2 1	A/3-7 A/3+1	90° 90°
Travesaño	681	0,70		-	A/3-50 A/3+44	90° 90°	-	A/3-50 A/3+44	90° 90°

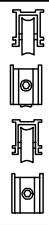
- Medidas en milímetros

- Dimensiones de Corte de Contramarco, en página 55

Detalle de Accesorios Ventana y Puerta Corrediza 3 Hojas			Ventana	Puerta
Código	Descripción	Forma	Cantidad	Cantidad
8362	Tornillo Parker 10 x 1½ T-1		28 Unidades	34 Unidades
8209	Cuña Chica		2A + 6H	
8210	Cuña Mediana			
8211	Cuña Grande			
8424	Tope Canal de Condensación T-91		4 Unidades	
8943	Felpa de 7x6 con Fin Seal		4A + 8H	
8181	Cierre Lateral Milano H-56 sin Kit		2 Unidades	
8168	Kit Delta p/cierre Lateral Milano			
8428	Tope Parante Lateral T-89		4 Unidades	
8429	Tope Parante Central T-90		8 Unidades	
8427	Rueda Ibiza Doble Regulable R-40 - 40 kg.		6 Unidades	
8430	Rueda Monza R-39			
8435	Rueda Imola R-39			
8437	Rueda Imola Simple R-41			
8441	Rueda Regulable R-42 - 40 kg.			
8445	Rueda Ibiza Doble R-42			
8454	Rueda Ibiza Simple R-40 - 20 kg.			
8436	Cruce Central de Hoja T-93		4 Unidades	
8946	Boca Desagüe T-94		s/m	
8366	Tapa Desagüe T-69		2 Unidades	
8416	Junta de Estanqueidad T-101		4 Unidades	

- Detalle de Accesorios para Fijación y Contramarco en página 55

- s/m : según medida

Tolerancia en Peso +/- 10% Tolerancia largo +10 mm -0 mm

09-06-23 DELTA.50

Vista

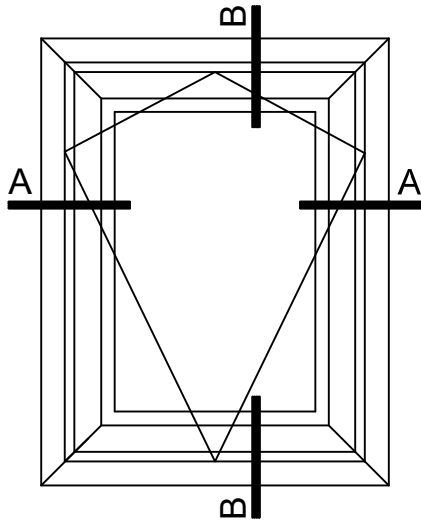

B-B Corte Vertical

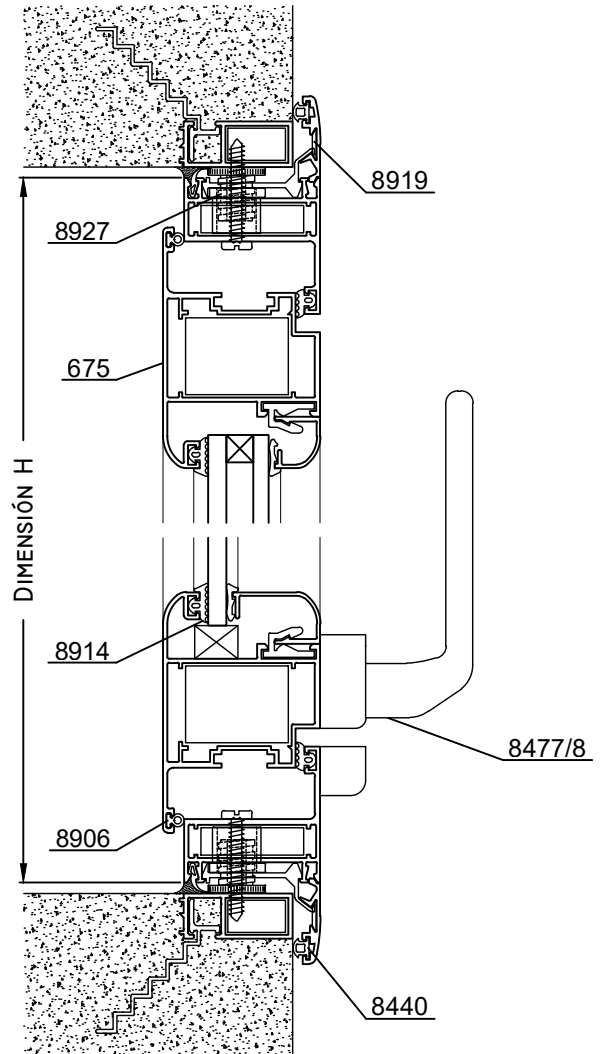

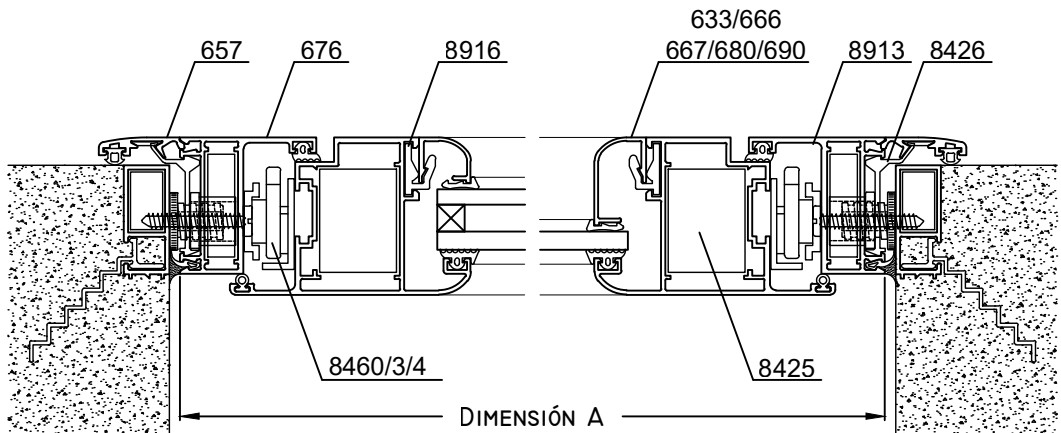

A-A Corte Horizontal



Escala 1:2.5











Tolerancia en Peso +/- 10% Tolerancia largo +10 mm -0 mm

09-06-23 DELTA.51

Dimensiones de Corte Ventana Desplazable						
Función	Código	Peso Kg/m	Forma	Cant.	Largo	Corte
Marco	676	0,72		2	A	45° 45°
				2	H	45° 45°
Hoja	675	1,07		2	A-32	45° 45°
				2	H-32	45° 45°
Contravidrio	Contravidrios Curvos	-	-	2	A-157	45° 45°
				2	H-157	45° 45°
	Contravidrios Rectos	-	-	2	A-157	90° 90°
				2	H-191	90° 90°

- Medidas en milímetros

- Dimensiones de Corte de Premarco y Contramarco, en página 55

Detalle de Accesorios Ventana Desplazable			
Código	Descripción	Forma	Cantidad
8423	Escuadra de Armado E-69		4 Unidades
8425	Escuadra Parante E-70		4 Unidades
8916	Clip Contravidrio T-96		s/m
8913	Burlete de Acristalamiento B-68		2A + 2H
8209	Cuña Chica		2A + 2H
8210	Cuña Mediana		
8211	Cuña Grande		
8906	Burlete AEL Europeo		2A + 2H
8914	Burlete de Hermeticidad B-67		2A + 2H
8477	Aldaba CP25		1 Unidad
8478	Aldaba Prima H-91		
8464	Tijera de Acero 259 mm. 50 kg. - 84°		1 Par
8460	Tijera de Acero 412 mm. 70 kg. - 90°		
8463	Tijera de Acero 558 mm. 74 kg. - 90°		
8471	Tijera de Acero 660 mm. 120 kg. - 20°		
8411	Tijera de Acero 262 mm. 37 kg. - 84°		
8412	Tijera de Acero 415 mm. 55 kg. - 90°		
8413	Tijera de Acero 567 mm. 75 kg. - 90°		
8414	Tijera de Acero 660 mm. 100 kg. - 20°		

s/m: según medida.

(a): En hojas de 900 mm o más de ancho se aconseja utilizar 2 aldabas de cierre por hoja.

H(\*): Altura de Hoja.

Tijeras Cod.8460/8463/8464/8471 marca Cotsword.

Tijeras Cod.8411/8412/8413/8414 marca Storm.

Nota: En hojas de 1200 mm o más de alto se aconseja utilizar un limitador de apertura (Cód. 8479 o 8481)

Vista

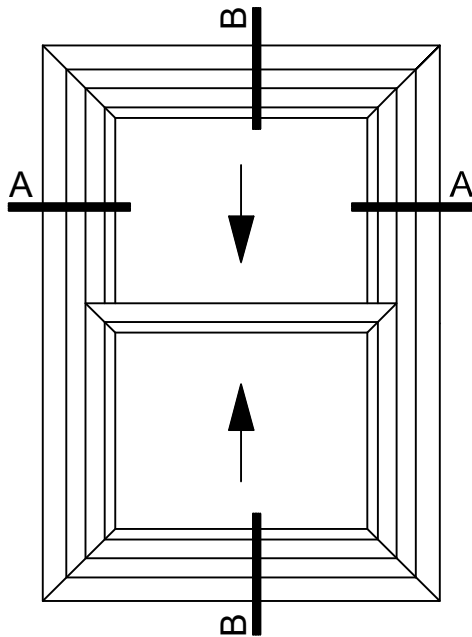

B-B Corte Vertical

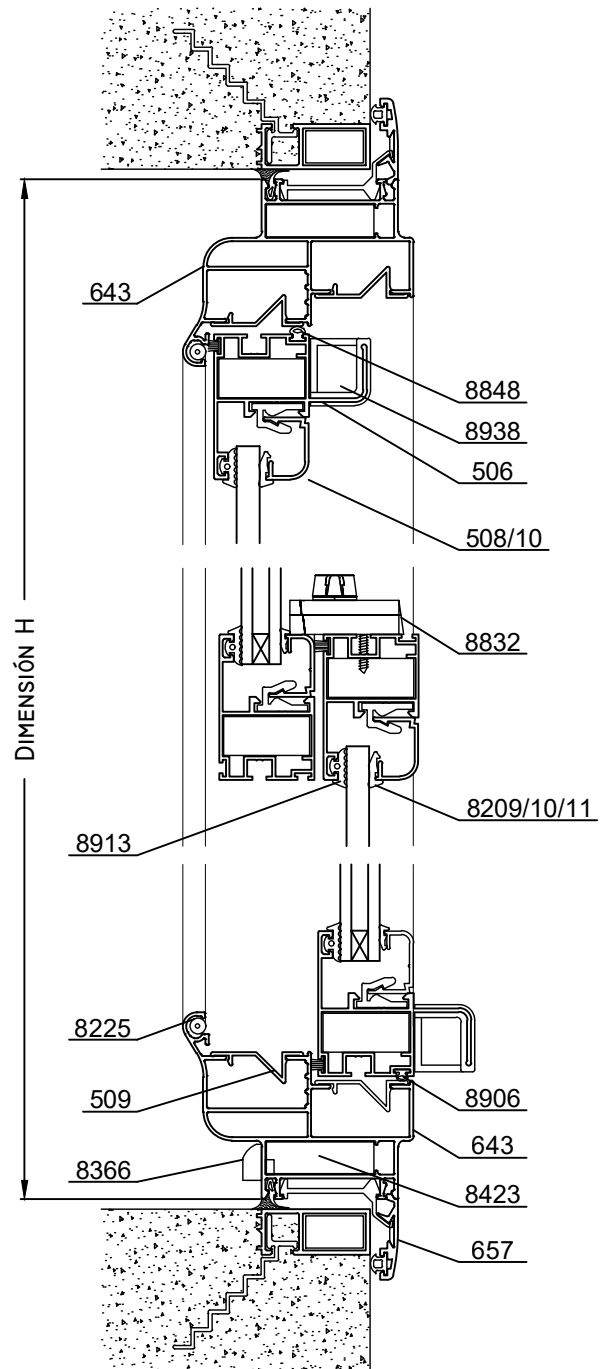

Medidas de Fabricación  
(Máximas / Mínimas)

Ancho mínimo: 460 mm.  
Ancho máximo: 1200 mm.  
Alto mínimo: 860 mm.  
Alto máximo: 1500 mm.

Nota:

Existe una alternativa de Cierre Central Coplanar, para las situaciones en las que no es posible utilizar el Cierre Convencional

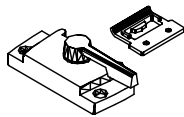



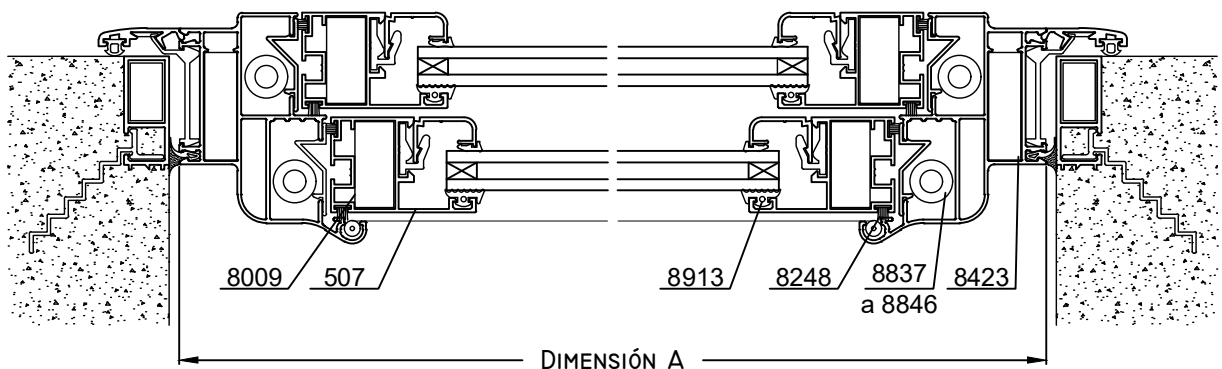

A - A Corte Horizontal



Escala 1:2.5















Tolerancia en Peso +/- 10% Tolerancia largo +10 mm -0 mm

09-06-23 DELTA.53



Dimensiones de Corte							
Código	Peso Kg/m	Forma	Función	Cant.	Largo	Corte	
643	1,10		Marco	2	A	45° 45°	
				2	H	45° 45°	
506	0,69		Zócalo / Cabezal	1	A-82	45° 45°	Hoja Interna
				1	A-100	45° 45°	Hoja Externa
507	0,56		Hoja	1	A-82	45° 45°	Hoja Interna
				1	A-100	45° 45°	Hoja Externa
				4	H/2-25	45° 45°	Hoja Interna / Externa
				2	A-137	45° 45°	Hoja Interna
508 (V.S.) 510 (D.V.H.)	-	-	Contra - Vidrio	2	A-155	45° 45°	Hoja Externa
				4	H/2-79	45° 45°	Hoja Interna / Externa
				2	A+54	45° 45°	
657	0,19		Contra - Marco	2	H+54	45° 45°	
				2		45° 45°	

Dimensiones de Corte Premarco: pág. 55

\* Medidas en milímetros



Detalle de Accesorios				
Ítem	Código	Descripción	Forma	Cantidad
Esc. de Armado	8423	Escuadra de Armado E-69		4 Unidades
	8009	Escuadra Hoja de Guillotina		8 Unidades
Clip	8916	Clip Contravidrios T-96		s/m
Tapón Lateral	8938	Tapón Lateral		4 Unidades
Burlete Vidrio	8913	Burlete de Acristalamiento B-68		4A + 2H
Cuña Vidrio	8209	Cuña Chica		4A + 2H
	8210	Cuña Mediana		
	8211	Cuña Grande		
Felpa	8247	Felpa de Polipropileno 5x5		2H
	8248	Felpa de Polipropileno 5x7		3A + 2H
Burlete Hermetic.	8848	Burlete de Hermeticidad GUA-162		1A
	8906	Burlete AEL Europeo		1A
Cierre Central	8832	Cierre Central Guillotina		1 Unidad
Cierre Lateral	8833	Cierre Lateral Guillotina		2 Pares
Patín Lateral	8834	Patín Lateral		2 Pares
Barra Pivot	8835	Barra Pivot		2 Pares
Compensadores	8837 / 46	Compensadores H-118 (13'' a 31'')		2 Pares
Tapa Desagüe	8366	Tapa Desagüe T-69		2 Unidades



- s/m: según medida.





Dimensiones de Corte Premarco y Contramarco				Paño Fijo / Ventanas			Puerta (Rebatir / Corrediza)		
Función	Código	Peso kg/m	Forma	Cant.	Largo	Corte	Cant.	Largo	Corte
Premarco	718	0,33		2	A+36	45° 45°	2	A+36	45° 45°
				2	H+36	45° 45°	2	H+36	45° 45°
Contramarco	657	0,19		2	A+53	45° 45°	1	A+27	45° 45°
				2	H+53	45° 45°	2	H+53	45° 90°

- Medidas en milímetros

Accesorios de Fijación			
Código	Descripción		Cantidad
8927	Taco de Regulación T-88		s/m
---	Tornillo de Fijación		s/m
8945	Tapa Cabeza de Tornillo T-95		s/m
8432	Burlete Marco Hermeticidad B-69		2A + 2H
8724	Escuadra Esquinera de Premarco		4 Unidades

Accesorios Premarco (Perfil 718)			
Código	Descripción		Cantidad
8969	Escuadra de Armado Premarco E-68		4 Unidades
8722	Grampa de Amure		s/m

Accesorios Contramarco (Perfil 657)			Paño Fijo / Ventanas	Puertas (Rebatir / Corrediza)
Código	Descripción		Cantidad	Cantidad
8919	Escuadra de Alineación E-66		4 Unidades	2 Unidades
8426	Clip Contramarco T-87		s/m	s/m
8440	Burlete Contramarco B-57		2A + 2H	2A + 2H

Accesorios Mosquitero Ventana y Puerta Corrediza (Perfiles 685 y 708)			
Código	Descripción		Cantidad
8438	Escuadra de Mosquitero E-73		4 Unidades
8223	Cordón de 5 milímetros B-9		1A + 2H
8449	Burlete Tope Mosquitero B-70		2H
8439	Patín Mosquitero R-43		4 Unidades
8940	Tornillo Botón, para Perfil 708, T-21		s/m

- s/m : según medida



Cantidades y Medidas de Perfil 9469 / Pletina Poliamida 9469 de Transmisión:  
- Descuento en Función de Hoja

Detalle de medidas para Oscilo Batiente Giesse					
Brazo tipo I Código 9207	Perfil / Poliamida	Denominación	Cant.	Largo	Corte
Ancho de hoja 410 a 570 mm.	9469	Varilla de transmisión	1	ANCHO DE HOJA - 355	90°
Alto de hoja hasta 1000 mm.	9469	Varilla de transmisión	2	ALTO DE HOJA - 207	90°

Brazo tipo II Código 9208	Perfil / Poliamida	Denominación	Cant.	Largo	Corte
Ancho de hoja 571 a 1700 mm.	9469	Varilla de transmisión	1	ANCHO DE HOJA - 510	90°
Alto de hoja hasta 1000 mm.	9469	Varilla de transmisión	2	ALTO DE HOJA - 207	90°

Ancho y Alto > 1000 mm.	Cierre Sup.	Denominación	Cant.	Largo	Corte
Ancho Mayor a 1000 mm.	9120	Cierre Sup. Horizontal	1	S/M	90°
Alto Mayor a 1000 mm.	9121	Cierre Sup. Vertical	2	S/M	90°

Ancho Mayor 1000 mm.	Brazo Sup.	Denominación	Cant.	Largo	Corte
Ancho Mayor a 1000 mm.	9120	Brazo Suplementario	1	S/M	-

El Compás Suplementario es Aconsejable para Ancho de Hoja entre 900 mm y 1100 mm con peso superior a los 100 kg y Obligatorio entre 1100 mm. a 1700 mm.

Detalle de medidas para Oscilo Batiente Fapim					
Compás Corto	Perfil / Poliamida	Denominación	Cant.	Largo	Corte
Ancho de hoja 402 a 750 mm.	9469	Varilla de transmisión	1	ANCHO DE HOJA - 496	90°
Alto de hoja hasta 1000 mm.	9469	Varilla de transmisión	1	ALTO DE HOJA / 2 - 191	90°
	9469	Varilla de transmisión	1	ALTO DE HOJA / 2 - 147	90°

Compás Medio	Perfil / Poliamida	Denominación	Cant.	Largo	Corte
Ancho de hoja 562 a 1200 mm.	9469	Varilla de transmisión	1	ANCHO DE HOJA - 372	90°
Alto de hoja hasta 1000 mm.	9469	Varilla de transmisión	1	ALTO DE HOJA / 2 - 191	90°
	9469	Varilla de transmisión	1	ALTO DE HOJA / 2 - 147	90°

Ancho y Alto > 1000 mm.	Cierre Sup.	Denominación	Cant.	Largo	Corte
Ancho Mayor a 1000 mm.	9237	Cierre Sup. Horizontal	2	S/M	90°
Alto Mayor a 1000 mm.	9237	Cierre Sup. Vertical	2	S/M	90°

Ancho Mayor 1000 mm.	Brazo Sup.	Denominación	Cant.	Largo	Corte
Ancho Mayor a 1000 mm.	9236	Brazo Suplementario	1	S/M	-